





# PULEGGE DENTATE PER CINGHIE POSITIVE - ISO 5294 TIMING BELT PULLEYS - ISO 5294

## MXL 025

**PASSO 0,80" (2,032 mm)**

**PER CINGHIE LARGHEZZA 1/4" (6,35 mm)**

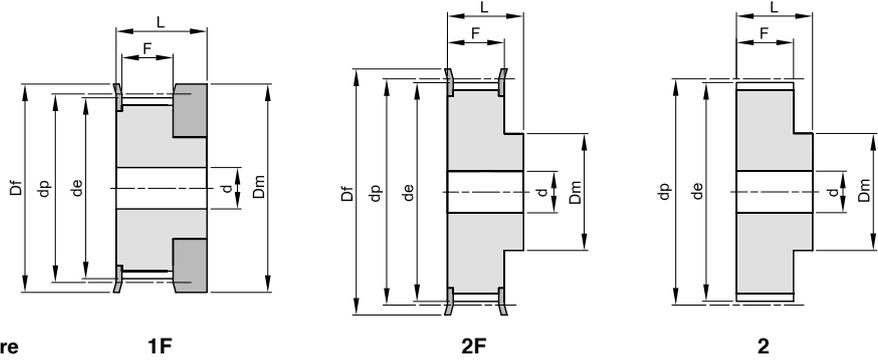

**Materiale: Alluminio UNI 9006 - T6 (Al)**  
adatto per l'ossidazione dura a spessore

descrizione	codice	tipo	materiale	denti	dp	de	Df	Dm	F	L	d	n° flangia	Kg.
16 MXL 025	12025016	1F	Al	16	10,35	9,84	15	15	8,5	16		101	0,01
18 MXL 025	12025018	1F	Al	18	11,64	11,13	16	16	8,5	16		102	0,01
20 MXL 025	12025020	1F	Al	20	12,94	12,43	16	16	8,5	16		102	0,01
22 MXL 025	12025022	2F	Al	22	14,23	13,72	18	10	11	16		104	0,01
24 MXL 025	12025024	2F	Al	24	15,52	15,02	18	10	11	16		104	0,01
28 MXL 025	12025028	2F	Al	28	18,11	17,60	23	11	11	16		107	0,01
30 MXL 025	12025030	2F	Al	30	19,40	18,90	23	12	11	16		107	0,02
32 MXL 025	12025032	2F	Al	32	20,70	20,19	25	14	11	16		108	0,02
36 MXL 025	12025036	2F	Al	36	23,29	22,78	28	16	11	16		109	0,02
40 MXL 025	12025040	2F	Al	40	25,87	25,36	32	18	11	16		110	0,03
42 MXL 025	12025042	2F	Al	42	27,17	26,66	32	18	11	16		110	0,03
44 MXL 025	12025044	2F	Al	44	28,46	27,95	36	18	11	16		111	0,03
48 MXL 025	12025048	2	Al	48	31,05	30,54		20	11	16			0,03
60 MXL 025	12025060	2	Al	60	38,81	38,30		24	11	16			0,04
72 MXL 025	12025072	2	Al	72	46,57	46,06		25	11	16	6		0,05



# PULEGGE DENTATE PER CINGHIE POSITIVE - ISO 5294

## TIMING BELT PULLEYS - ISO 5294

### XL 037

PASSO 1/5" (5,08 mm)

PER CINGHIE LARGHEZZA 3/8" (9,52 mm)

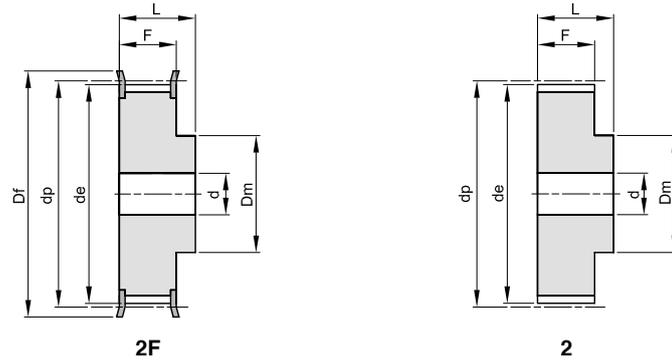

Materiale: Alluminio UNI 9006 - T6 (Al)  
adatto per l'ossidazione dura a spessore

descrizione	codice	tipo	materiale	denti	dp	de	Df	Dm	F	L	d	n° flangia	Kg.
10 XL 037	13037010	2F	Al	10	16,17	15,66	23	10	14,3	20		201	0,01
11 XL 037	13037011	2F	Al	11	17,79	17,28	23	10	14,3	20		201	0,01
12 XL 037	13037012	2F	Al	12	19,40	18,90	25	10	14,3	20		203	0,01
13 XL 037	13037013	2F	Al	13	21,02	20,51	25	10	14,3	20		203	0,01
14 XL 037	13037014	2F	Al	14	22,64	22,13	28	16	14,3	20		204	0,02
15 XL 037	13037015	2F	Al	15	24,25	23,75	28	16	14,3	20		204	0,02
16 XL 037	13037016	2F	Al	16	25,87	25,36	32	16	14,3	20		205	0,03
17 XL 037	13037017	2F	Al	17	27,49	26,98	32	20	14,3	20		205	0,03
18 XL 037	13037018	2F	Al	18	29,11	28,60	36	20	14,3	20		206	0,04
19 XL 037	13037019	2F	Al	19	30,72	30,21	36	20	14,3	22		206	0,04
20 XL 037	13037020	2F	Al	20	32,34	31,83	38	25	14,3	22		207	0,05
21 XL 037	13037021	2F	Al	21	33,96	33,45	38	25	14,3	22		207	0,05
22 XL 037	13037022	2F	Al	22	35,57	35,07	42	25	14,3	22		208	0,06
24 XL 037	13037024	2F	Al	24	38,81	38,30	44	30	14,3	22		209	0,06
26 XL 037	13037026	2F	Al	26	42,04	41,53	48	30	14,3	22	8	210	0,09
27 XL 037	13037027	2F	Al	27	43,66	43,15	48	34	14,3	22	8	210	0,09
28 XL 037	13037028	2F	Al	28	45,28	44,77	51	34	14,3	22	8	211	0,10
30 XL 037	13037030	2F	Al	30	48,51	48,00	54	38	14,3	22	8	212	0,12
32 XL 037	13037032	2F	Al	32	51,74	51,24	57	38	14,3	25	8	213	0,12
34 XL 037	13037034	2F	Al	34	54,98	54,47	60	38	14,3	25	8	214	0,13
35 XL 037	13037035	2F	Al	35	56,60	56,09	63	38	14,3	25	8	215	0,14
36 XL 037	13037036	2	Al	36	58,21	57,70		45	14,3	25	8		0,14
38 XL 037	13037038	2	Al	38	61,45	60,94		45	14,3	25	8		0,15
40 XL 037	13037040	2	Al	40	64,68	64,17		45	14,3	25	8		0,16
42 XL 037	13037042	2	Al	42	67,91	67,41		45	14,3	25	8		0,18
44 XL 037	13037044	2	Al	44	71,15	70,64		45	14,3	25	8		0,19
48 XL 037	13037048	2	Al	48	77,62	77,11		45	14,3	25	10		0,19
52 XL 037	13037052	2	Al	52	84,08	83,57		45	14,3	25	10		0,19
60 XL 037	13037060	2	Al	60	97,02	96,51		45	14,3	25	10		0,22
72 XL 037	13037072	2	Al	72	116,42	115,92		45	14,3	25	10		0,44



# PULEGGE DENTATE PER CINGHIE POSITIVE - ISO 5294

## TIMING BELT PULLEYS - ISO 5294

### L 050

PASSO 3/8" (9,525 mm)

PER CINGHIE LARGHEZZA 1/2" (12,7 mm)

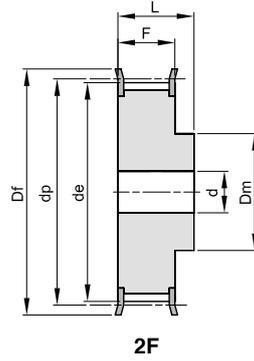

2F

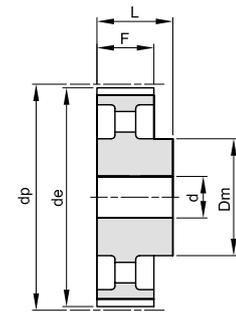

4

Materiale: Acciaio (St)  
Materiale: Ghisa (GG)

descrizione	codice	tipo	materiale	denti	dp	de	Df	Dm	F	L	d	n° flangia	Kg.
10 L 050	14050010	2F	St	10	30,32	29,56	36	20	19,0	28	8	300	0,11
11 L 050	14050011	2F	St	11	33,35	32,59	38	24	19,0	30	8	301	0,14
12 L 050	14050012	2F	St	12	36,38	35,62	42	24	19,0	30	8	302	0,17
13 L 050	14050013	2F	St	13	39,41	38,65	44	28	19,0	30	8	303	0,21
14 L 050	14050014	2F	St	14	42,44	41,68	48	28	19,0	30	8	304	0,24
15 L 050	14050015	2F	St	15	45,48	44,72	51	34	19,0	30	8	305	0,29
16 L 050	14050016	2F	St	16	48,51	47,75	54	36	19,0	32	8	306	0,33
17 L 050	14050017	2F	St	17	51,54	50,78	57	36	19,0	32	10	307	0,38
18 L 050	14050018	2F	St	18	54,57	53,81	60	40	19,0	32	10	308	0,44
19 L 050	14050019	2F	St	19	57,61	56,84	63	40	19,0	32	10	309	0,47
20 L 050	14050020	2F	St	20	60,64	59,88	66	40	19,0	32	10	310	0,51
21 L 050	14050021	2F	St	21	63,67	62,91	71	45	19,0	32	10	311	0,60
22 L 050	14050022	2F	St	22	66,70	65,94	75	45	19,0	32	10	312	0,64
23 L 050	14050023	2F	St	23	69,73	68,97	79	55	19,0	32	10	313	0,78
24 L 050	14050024	2F	St	24	72,77	72,00	79	55	19,0	32	10	313	0,81
25 L 050	14050025	2F	St	25	75,80	75,04	83	58	19,0	32	10	314	0,89
26 L 050	14050026	2F	St	26	78,83	78,07	87	58	19,0	32	12	315	0,94
27 L 050	14050027	2F	St	27	81,86	81,10	87	58	19,0	32	12	315	0,99
28 L 050	14050028	2F	St	28	84,89	84,13	91	58	19,0	32	12	316	1,04
30 L 050	14050030	2F	St	30	90,96	90,20	97	70	19,0	32	12	318	1,27
32 L 050	14050032	2F	St	32	97,03	96,26	103	70	19,0	32	12	320	1,41
33 L 050	14050033	2F	St	33	100,05	99,29	106	70	19,0	32	12	321	1,49
34 L 050	14050034	2F	St	34	103,08	102,32	111	70	19,0	32	12	322	1,57
35 L 050	14050035	2F	St	35	106,12	105,35	111	70	19,0	32	12	322	1,62
36 L 050	14050036	2F	St	36	109,15	108,39	115	70	19,0	32	12	323	1,70
40 L 050	14050040	2F	St	40	121,29	120,51	127	70	19,0	32	12	327	2,03
42 L 050	14050042	2F	St	42	127,34	126,58	135	70	19,0	32	12	328	2,21
44 L 050	14050044	2F	St	44	133,40	132,64	140	70	19,0	32	12	330	2,38
45 L 050	14050045	2F	St	45	136,44	135,67	143	70	19,0	32	12	331	2,48
48 L 050	14050048	2F	St	48	145,53	144,77	152	70	19,0	32	12	334	2,78
50 L 050	14050050	4	GG	50	151,60	150,83		70	19,0	32	14		1,74
52 L 050	14050052	4	GG	52	157,66	156,90		70	19,0	32	14		1,80
56 L 050	14050056	4	GG	56	169,79	169,02		70	19,0	32	14		1,87
57 L 050	14050057	4	GG	57	172,82	172,06		70	19,0	32	14		1,88
60 L 050	14050060	4	GG	60	181,91	181,15		75	19,0	42	14		2,41
72 L 050	14050072	4	GG	72	218,29	217,53		75	19,0	42	14		2,82
84 L 050	14050084	4	GG	84	254,68	253,92		75	19,0	42	14		3,08
96 L 050	14050096	4	GG	96	291,06	290,30		75	19,0	42	14		3,42



# PULEGGE DENTATE PER CINGHIE POSITIVE - ISO 5294

## TIMING BELT PULLEYS - ISO 5294

### L 075

PASSO 3/8" (9,525 mm)

PER CINGHIE LARGHEZZA 3/4" (19,05 mm)

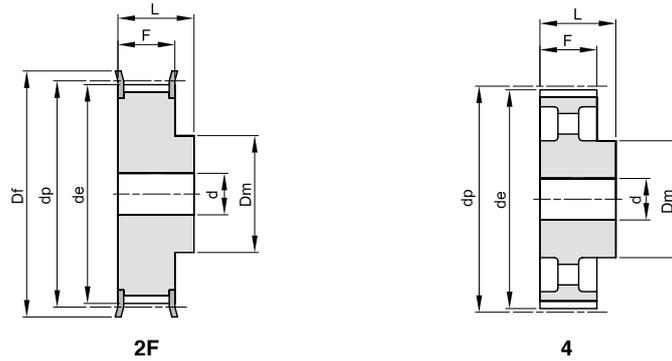

Materiale: Acciaio (St)  
Materiale: Ghisa (GG)

descrizione	codice	tipo	materiale	denti	dp	de	Df	Dm	F	L	d	n° flangia	Kg.
10 L 075	14075010	2F	St	10	30,32	29,56	36	20	25,4	38	8	300	0,14
11 L 075	14075011	2F	St	11	33,35	32,59	38	24	25,4	38	8	301	0,18
12 L 075	14075012	2F	St	12	36,38	35,62	42	24	25,4	38	8	302	0,22
13 L 075	14075013	2F	St	13	39,41	38,65	44	28	25,4	38	8	303	0,26
14 L 075	14075014	2F	St	14	42,44	41,68	48	28	25,4	38	8	304	0,30
15 L 075	14075015	2F	St	15	45,48	44,72	51	34	25,4	38	8	305	0,37
16 L 075	14075016	2F	St	16	48,51	47,75	54	36	25,4	38	8	306	0,43
17 L 075	14075017	2F	St	17	51,54	50,78	57	36	25,4	38	10	307	0,46
18 L 075	14075018	2F	St	18	54,57	53,81	60	40	25,4	38	10	308	0,54
19 L 075	14075019	2F	St	19	57,61	56,84	63	40	25,4	38	10	309	0,58
20 L 075	14075020	2F	St	20	60,64	59,88	66	40	25,4	38	10	310	0,64
21 L 075	14075021	2F	St	21	63,67	62,91	71	45	25,4	38	10	311	0,71
22 L 075	14075022	2F	St	22	66,70	65,94	75	45	25,4	38	10	312	0,79
23 L 075	14075023	2F	St	23	69,73	68,97	79	55	25,4	38	10	313	0,94
24 L 075	14075024	2F	St	24	72,77	72,00	79	55	25,4	38	10	313	1,00
25 L 075	14075025	2F	St	25	75,80	75,04	83	58	25,4	38	10	314	1,10
26 L 075	14075026	2F	St	26	78,83	78,07	87	58	25,4	38	12	315	1,16
27 L 075	14075027	2F	St	27	81,86	81,10	87	58	25,4	38	12	315	1,22
28 L 075	14075028	2F	St	28	84,89	84,13	91	58	25,4	38	12	316	1,30
30 L 075	14075030	2F	St	30	90,96	90,20	97	70	25,4	38	12	318	1,47
32 L 075	14075032	2F	St	32	97,03	96,26	103	70	25,4	38	12	320	1,75
33 L 075	14075033	2F	St	33	100,05	99,29	106	70	25,4	38	12	321	1,85
34 L 075	14075034	2F	St	34	103,08	102,32	111	70	25,4	38	12	322	1,93
35 L 075	14075035	2F	St	35	106,12	105,35	111	70	25,4	38	12	322	2,03
36 L 075	14075036	2F	St	36	109,15	108,39	115	70	25,4	38	12	323	2,14
40 L 075	14075040	2F	St	40	121,29	120,51	127	70	25,4	38	12	327	2,56
42 L 075	14075042	2F	St	42	127,34	126,58	135	70	25,4	38	12	328	2,81
44 L 075	14075044	2F	St	44	133,40	132,64	140	70	25,4	38	12	330	3,02
45 L 075	14075045	2F	St	45	136,44	135,67	143	70	25,4	38	12	331	3,16
48 L 075	14075048	2F	St	48	145,53	144,77	152	70	25,4	38	12	334	3,57
50 L 075	14075050	4	GG	50	151,60	150,83		70	25,4	38	14		2,10
52 L 075	14075052	4	GG	52	157,66	156,90		70	25,4	38	14		2,13
56 L 075	14075056	4	GG	56	169,79	169,02		70	25,4	38	14		2,27
57 L 075	14075057	4	GG	57	172,82	172,06		70	25,4	38	14		2,28
60 L 075	14075060	4	GG	60	181,91	181,15		75	25,4	45	14		2,70
72 L 075	14075072	4	GG	72	218,29	217,53		75	25,4	45	14		3,19
84 L 075	14075084	4	GG	84	254,68	253,92		75	25,4	45	14		3,64
96 L 075	14075096	4	GG	96	291,06	290,30		75	25,4	45	14		4,04



# PULEGGE DENTATE PER CINGHIE POSITIVE - ISO 5294

## TIMING BELT PULLEYS - ISO 5294

### L 100

PASSO 3/8" (9,525 mm)

PER CINGHIE LARGHEZZA 1" (25,4 mm)

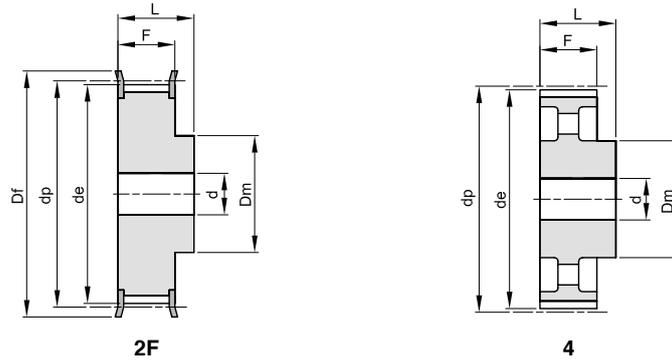

Materiale: Acciaio (St)  
Materiale: Ghisa (GG)

descrizione	codice	tipo	materiale	denti	dp	de	Df	Dm	F	L	d	n° flangia	Kg.
10 L 100	14100010	2F	St	10	30,32	29,56	36	20	31,8	45	8	300	0,17
11 L 100	14100011	2F	St	11	33,35	32,59	38	24	31,8	45	8	301	0,22
12 L 100	14100012	2F	St	12	36,38	35,62	42	24	31,8	45	8	302	0,26
13 L 100	14100013	2F	St	13	39,41	38,65	44	28	31,8	45	8	303	0,32
14 L 100	14100014	2F	St	14	42,44	41,68	48	28	31,8	45	10	304	0,35
15 L 100	14100015	2F	St	15	45,48	44,72	51	34	31,8	45	10	305	0,43
16 L 100	14100016	2F	St	16	48,51	47,75	54	36	31,8	45	10	306	0,50
17 L 100	14100017	2F	St	17	51,54	50,78	57	36	31,8	45	10	307	0,56
18 L 100	14100018	2F	St	18	54,57	53,81	60	40	31,8	45	10	308	0,64
19 L 100	14100019	2F	St	19	57,61	56,84	63	40	31,8	45	10	309	0,70
20 L 100	14100020	2F	St	20	60,64	59,88	66	40	31,8	45	10	310	0,77
21 L 100	14100021	2F	St	21	63,67	62,91	71	45	31,8	45	10	311	0,88
22 L 100	14100022	2F	St	22	66,70	65,94	75	45	31,8	45	12	312	0,95
23 L 100	14100023	2F	St	23	69,73	68,97	79	55	31,8	45	12	313	1,11
24 L 100	14100024	2F	St	24	72,77	72,00	79	55	31,8	45	12	313	1,18
25 L 100	14100025	2F	St	25	75,80	75,04	83	58	31,8	45	12	314	1,30
26 L 100	14100026	2F	St	26	78,83	78,07	87	58	31,8	45	12	315	1,40
27 L 100	14100027	2F	St	27	81,86	81,10	87	58	31,8	45	12	315	1,47
28 L 100	14100028	2F	St	28	84,89	84,13	91	58	31,8	45	12	316	1,58
30 L 100	14100030	2F	St	30	90,96	90,20	97	70	31,8	45	12	318	1,78
32 L 100	14100032	2F	St	32	97,03	96,26	103	70	31,8	45	12	320	2,11
33 L 100	14100033	2F	St	33	100,05	99,29	106	70	31,8	45	12	321	2,23
34 L 100	14100034	2F	St	34	103,08	102,32	111	70	31,8	45	12	322	2,39
35 L 100	14100035	2F	St	35	106,12	105,35	111	70	31,8	45	12	322	2,45
36 L 100	14100036	2F	St	36	109,15	108,39	115	70	31,8	45	12	323	2,59
40 L 100	14100040	2F	St	40	121,29	120,51	127	70	31,8	45	12	327	3,13
42 L 100	14100042	2F	St	42	127,34	126,58	135	70	31,8	45	12	328	3,43
44 L 100	14100044	2F	St	44	133,40	132,64	140	70	31,8	45	12	330	3,72
45 L 100	14100045	2F	St	45	136,44	135,67	143	70	31,8	45	12	331	3,89
48 L 100	14100048	2F	St	48	145,53	144,77	152	70	31,8	45	12	334	4,38
50 L 100	14100050	4	GG	50	151,60	150,83		70	31,8	45	14		2,41
52 L 100	14100052	4	GG	52	157,66	156,90		70	31,8	45	14		2,55
56 L 100	14100056	4	GG	56	169,79	169,02		70	31,8	45	14		2,65
57 L 100	14100057	4	GG	57	172,82	172,06		70	31,8	45	14		2,71
60 L 100	14100060	4	GG	60	181,91	181,15		75	31,8	45	14		3,11
72 L 100	14100072	4	GG	72	218,29	217,53		75	31,8	45	14		3,65
84 L 100	14100084	4	GG	84	254,68	253,92		75	31,8	45	14		4,12
96 L 100	14100096	4	GG	96	291,06	290,30		75	31,8	45	14		4,60



# PULEGGE DENTATE PER CINGHIE POSITIVE - ISO 5294

## TIMING BELT PULLEYS - ISO 5294

### H 075

PASSO 1/2" (12,7 mm)

PER CINGHIE LARGHEZZA 3/4" (19,05 mm)

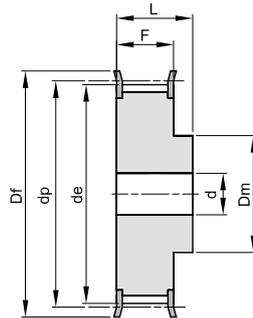

2F

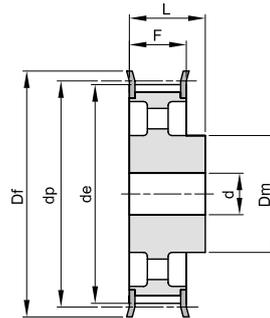

4F

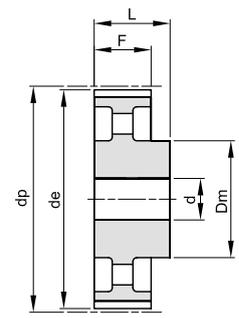

4

Materiale: Acciaio (St)  
Materiale: Ghisa (GG)

descrizione	codice	tipo	materiale	denti	dp	de	Df	Dm	F	L	d	n° flangia	Kg.
14 H 075	15075014	2F	St	14	56,59	55,22	63	40	26,4	40	10	309	0,58
15 H 075	15075015	2F	St	15	60,64	59,27	66	45	26,4	40	10	310	0,69
16 H 075	15075016	2F	St	16	64,68	63,31	71	45	26,4	40	10	311	0,77
17 H 075	15075017	2F	St	17	68,72	67,35	75	45	26,4	40	12	312	0,84
18 H 075	15075018	2F	St	18	72,77	71,39	79	55	26,4	40	12	313	1,01
19 H 075	15075019	2F	St	19	76,81	75,44	83	60	26,4	40	12	314	1,15
20 H 075	15075020	2F	St	20	80,85	79,48	87	62	26,4	40	12	315	1,27
21 H 075	15075021	2F	St	21	84,89	83,52	91	65	26,4	40	12	316	1,41
22 H 075	15075022	2F	St	22	88,94	87,56	93	68	26,4	40	12	317	1,55
23 H 075	15075023	2F	St	23	92,98	91,61	97	72	26,4	40	12	318	1,71
24 H 075	15075024	2F	St	24	97,03	95,65	103	72	26,4	40	12	320	1,83
25 H 075	15075025	2F	St	25	101,06	99,69	106	72	26,4	40	12	321	1,96
26 H 075	15075026	2F	St	26	105,11	103,73	111	80	26,4	40	12	322	2,19
27 H 075	15075027	2F	St	27	109,15	107,78	115	80	26,4	40	12	323	2,32
28 H 075	15075028	2F	St	28	113,19	111,82	119	80	26,4	40	12	325	2,47
30 H 075	15075030	2F	St	30	121,29	119,90	127	80	26,4	40	14	327	2,76
32 H 075	15075032	2F	St	32	129,36	127,99	135	80	26,4	40	14	328	3,08
33 H 075	15075033	2F	St	33	133,40	132,03	140	80	26,4	40	14	330	3,25
34 H 075	15075034	2F	St	34	137,45	136,07	143	80	26,4	40	14	331	3,42
35 H 075	15075035	2F	St	35	141,49	140,12	148	80	26,4	40	14	333	3,61
36 H 075	15075036	2F	St	36	145,53	144,16	152	80	26,4	40	14	334	3,79
38 H 075	15075038	2F	St	38	153,62	152,24	158	80	26,4	40	14	335	4,16
40 H 075	15075040	2F	St	40	161,70	160,33	168	80	26,4	40	14	338	4,58
44 H 075	15075044	4F	GG	44	177,87	176,50	184	80	26,4	40	18	339	2,57
48 H 075	15075048	4F	GG	48	194,04	192,67	200	90	26,4	45	18	342	3,56
50 H 075	15075050	4	GG	50	202,13	200,75		90	26,4	45	18		3,74



# PULEGGE DENTATE PER CINGHIE POSITIVE - ISO 5294

## TIMING BELT PULLEYS - ISO 5294

### H 100

PASSO 1/2" (12,7 mm)

PER CINGHIE LARGHEZZA 1" (25,4 mm)

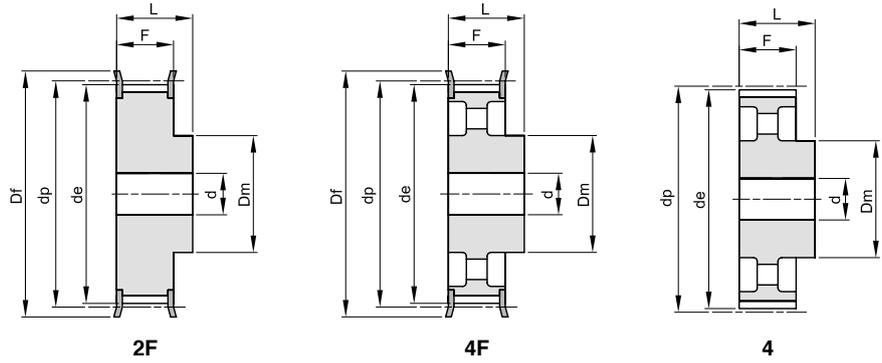

Materiale: Acciaio (St)  
Materiale: Ghisa (GG)

descrizione	codice	tipo	materiale	denti	dp	de	Df	Dm	F	L	d	n° flangia	Kg.
14 H 100	15100014	2F	St	14	56,59	55,22	63	40	31,8	45	12	309	0,65
15 H 100	15100015	2F	St	15	60,64	59,27	66	45	31,8	45	12	310	0,77
16 H 100	15100016	2F	St	16	64,68	63,31	71	45	31,8	45	12	311	0,87
17 H 100	15100017	2F	St	17	68,72	67,35	75	45	31,8	45	12	312	0,97
18 H 100	15100018	2F	St	18	72,77	71,39	79	55	31,8	45	12	313	1,16
19 H 100	15100019	2F	St	19	76,81	75,44	83	60	31,8	45	14	314	1,30
20 H 100	15100020	2F	St	20	80,85	79,48	87	62	31,8	45	14	315	1,44
21 H 100	15100021	2F	St	21	84,89	83,52	91	65	31,8	45	14	316	1,60
22 H 100	15100022	2F	St	22	88,94	87,56	93	68	31,8	45	14	317	1,76
23 H 100	15100023	2F	St	23	92,98	91,61	97	72	31,8	45	14	318	1,94
24 H 100	15100024	2F	St	24	97,03	95,65	103	72	31,8	45	14	320	2,09
25 H 100	15100025	2F	St	25	101,06	99,69	106	72	31,8	45	14	321	2,24
26 H 100	15100026	2F	St	26	105,11	103,73	111	80	31,8	45	14	322	2,49
27 H 100	15100027	2F	St	27	109,15	107,78	115	80	31,8	45	14	323	2,66
28 H 100	15100028	2F	St	28	113,19	111,82	119	80	31,8	45	14	325	2,83
29 H 100	15100029	2F	St	29	117,23	115,86	123	80	31,8	45	14	326	3,01
30 H 100	15100030	2F	St	30	121,29	119,90	127	80	31,8	45	14	327	3,19
32 H 100	15100032	2F	St	32	129,36	127,99	135	80	31,8	45	14	328	3,57
33 H 100	15100033	2F	St	33	133,40	132,03	140	80	31,8	45	14	330	3,79
34 H 100	15100034	2F	St	34	137,45	136,07	143	80	31,8	45	14	331	3,99
35 H 100	15100035	2F	St	35	141,49	140,12	148	80	31,8	45	14	333	4,20
36 H 100	15100036	2F	St	36	145,53	144,16	152	80	31,8	45	14	334	4,44
38 H 100	15100038	2F	St	38	153,62	152,24	158	80	31,8	45	14	335	4,90
40 H 100	15100040	2F	St	40	161,70	160,33	168	80	31,8	45	14	338	5,39
44 H 100	15100044	4F	GG	44	177,87	176,50	184	80	31,8	50	18	339	3,37
45 H 100	15100045	4F	GG	45	181,91	180,54	192	80	31,8	50	18	340	3,57
48 H 100	15100048	4F	GG	48	194,04	192,67	200	90	31,8	50	18	342	4,10
50 H 100	15100050	4	GG	50	202,13	200,75		90	31,8	50	18		4,24
52 H 100	15100052	4	GG	52	210,21	208,84		90	31,8	50	18		4,32
58 H 100	15100058	4	GG	58	234,47	233,09		90	31,8	50	18		4,61
60 H 100	15100060	4	GG	60	242,55	241,18		100	31,8	50	18		5,30
70 H 100	15100070	4	GG	70	282,98	281,61		100	31,8	55	18		6,13
72 H 100	15100072	4	GG	72	291,06	289,69		120	31,8	55	18		7,47
84 H 100	15100084	4	GG	84	339,57	338,20		120	31,8	55	18		8,52
96 H 100	15100096	4	GG	96	388,08	386,71		120	31,8	60	18		10,25
120 H 100	15100120	4	GG	120	485,10	483,73		120	31,8	60	18		13,09



# PULEGGE DENTATE PER CINGHIE POSITIVE - ISO 5294

## TIMING BELT PULLEYS - ISO 5294

### H 150

PASSO 1/2" (12,7 mm)

PER CINGHIE LARGHEZZA 1 1/2 (38,1 mm)

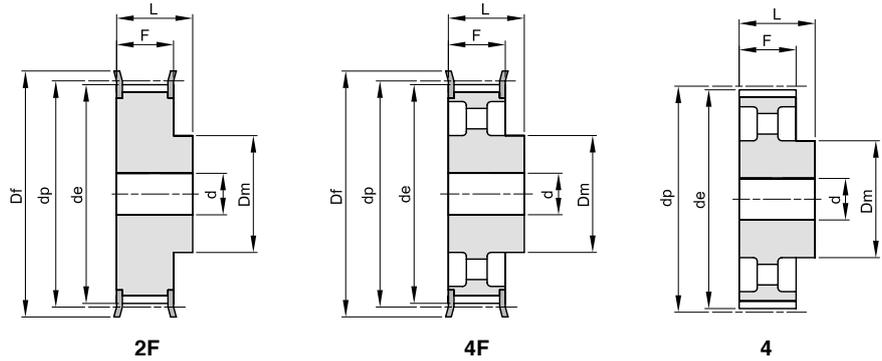

Materiale: Acciaio (St)  
Materiale: Ghisa (GG)

descrizione	codice	tipo	materiale	denti	dp	de	Df	Dm	F	L	d	n° flangia	Kg.
14 H 150	15150014	2F	St	14	56,59	55,22	63	40	46,0	58	18	309	0,81
15 H 150	15150015	2F	St	15	60,64	59,27	66	45	46,0	58	18	310	0,97
16 H 150	15150016	2F	St	16	64,68	63,31	71	45	46,0	58	18	311	1,11
17 H 150	15150017	2F	St	17	68,72	67,35	75	45	46,0	58	18	312	1,25
18 H 150	15150018	2F	St	18	72,77	71,39	79	55	46,0	58	18	313	1,48
19 H 150	15150019	2F	St	19	76,81	75,44	83	60	46,0	58	18	314	1,68
20 H 150	15150020	2F	St	20	80,85	79,48	87	62	46,0	58	18	315	1,88
21 H 150	15150021	2F	St	21	84,89	83,52	91	65	46,0	58	18	316	2,08
22 H 150	15150022	2F	St	22	88,94	87,56	93	68	46,0	58	18	317	2,30
23 H 150	15150023	2F	St	23	92,98	91,61	97	72	46,0	58	18	318	2,54
24 H 150	15150024	2F	St	24	97,03	95,65	103	72	46,0	58	18	320	2,75
25 H 150	15150025	2F	St	25	101,06	99,69	106	72	46,0	58	18	321	2,97
26 H 150	15150026	2F	St	26	105,11	103,73	111	80	46,0	58	18	322	3,29
27 H 150	15150027	2F	St	27	109,15	107,78	115	80	46,0	58	18	323	3,52
28 H 150	15150028	2F	St	28	113,19	111,82	119	80	46,0	58	18	325	3,78
29 H 150	15150029	2F	St	29	117,23	115,86	123	80	46,0	58	18	326	4,03
30 H 150	15150030	2F	St	30	121,29	119,90	127	80	46,0	58	18	327	4,29
32 H 150	15150032	2F	St	32	129,36	127,99	135	80	46,0	58	18	328	4,86
33 H 150	15150033	2F	St	33	133,40	132,03	140	80	46,0	58	18	330	5,15
34 H 150	15150034	2F	St	34	137,45	136,07	143	80	46,0	58	18	331	5,46
35 H 150	15150035	2F	St	35	141,49	140,12	148	80	46,0	58	18	333	5,78
36 H 150	15150036	2F	St	36	145,53	144,16	152	80	46,0	58	18	334	6,09
38 H 150	15150038	2F	St	38	153,62	152,24	158	80	46,0	58	18	335	6,74
40 H 150	15150040	2F	St	40	161,70	160,33	168	80	46,0	58	18	338	7,46
44 H 150	15150044	4F	GG	44	177,87	176,50	184	80	46,0	58	18	339	4,29
45 H 150	15150045	4F	GG	45	181,91	180,54	192	80	46,0	58	18	340	4,44
48 H 150	15150048	4F	GG	48	194,04	192,67	200	90	46,0	65	18	342	5,41
50 H 150	15150050	4	GG	50	202,13	200,75		90	46,0	65	18		5,59
52 H 150	15150052	4	GG	52	210,21	208,84		90	46,0	65	18		5,79
58 H 150	15150058	4	GG	58	234,47	233,09		90	46,0	65	18		6,15
60 H 150	15150060	4	GG	60	242,55	241,18		100	46,0	65	18		7,08
70 H 150	15150070	4	GG	70	282,98	281,61		100	46,0	65	24		7,77
72 H 150	15150072	4	GG	72	291,06	289,69		120	46,0	65	24		9,70
84 H 150	15150084	4	GG	84	339,57	338,20		120	46,0	65	24		10,99
96 H 150	15150096	4	GG	96	388,08	386,71		120	46,0	65	24		12,24
120 H 150	15150120	4	GG	120	485,10	483,73		120	46,0	65	24		16,17



# PULEGGE DENTATE PER CINGHIE POSITIVE - ISO 5294

## TIMING BELT PULLEYS - ISO 5294

### H 200

PASSO 1/2" (12,7 mm)

PER CINGHIE LARGHEZZA 2" (50,8 mm)

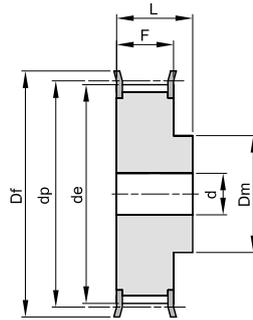

2F

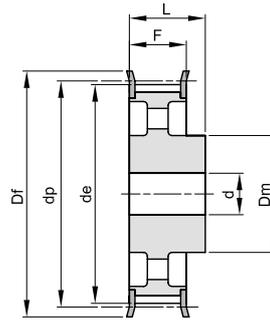

4F

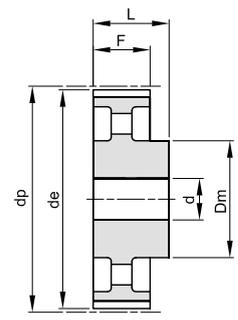

4

Materiale: Acciaio (St)  
Materiale: Ghisa (GG)

descrizione	codice	tipo	materiale	denti	dp	de	Df	Dm	F	L	d	n° flangia	Kg.
14 H 200	15200014	2F	St	14	56,59	55,22	63	40	58,7	70	18	309	1,10
15 H 200	15200015	2F	St	15	60,64	59,27	66	45	58,7	70	18	310	1,33
16 H 200	15200016	2F	St	16	64,68	63,31	71	45	58,7	70	18	311	1,54
17 H 200	15200017	2F	St	17	68,72	67,35	75	45	58,7	70	18	312	1,69
18 H 200	15200018	2F	St	18	72,77	71,39	79	55	58,7	70	18	313	1,95
19 H 200	15200019	2F	St	19	76,81	75,44	83	60	58,7	70	18	314	2,20
20 H 200	15200020	2F	St	20	80,85	79,48	87	62	58,7	70	18	315	2,44
21 H 200	15200021	2F	St	21	84,89	83,52	91	65	58,7	70	18	316	2,70
22 H 200	15200022	2F	St	22	88,94	87,56	93	68	58,7	70	18	317	2,97
23 H 200	15200023	2F	St	23	92,98	91,61	97	72	58,7	70	18	318	3,25
24 H 200	15200024	2F	St	24	97,03	95,65	103	72	58,7	70	18	320	3,56
25 H 200	15200025	2F	St	25	101,06	99,69	106	72	58,7	70	18	321	3,81
26 H 200	15200026	2F	St	26	105,11	103,73	111	80	58,7	70	18	322	4,18
27 H 200	15200027	2F	St	27	109,15	107,78	115	80	58,7	70	18	323	4,49
28 H 200	15200028	2F	St	28	113,19	111,82	119	80	58,7	70	18	325	4,81
29 H 200	15200029	2F	St	29	117,23	115,86	123	80	58,7	70	18	326	5,14
30 H 200	15200030	2F	St	30	121,29	119,90	127	80	58,7	70	18	327	5,47
32 H 200	15200032	2F	St	32	129,36	127,99	135	80	58,7	70	18	328	6,17
33 H 200	15200033	2F	St	33	133,40	132,03	140	80	58,7	70	18	330	6,56
34 H 200	15200034	2F	St	34	137,45	136,07	143	80	58,7	70	18	331	6,94
35 H 200	15200035	2F	St	35	141,49	140,12	148	80	58,7	70	18	333	7,34
36 H 200	15200036	2F	St	36	145,53	144,16	152	80	58,7	70	18	334	7,75
38 H 200	15200038	2F	St	38	153,62	152,24	158	80	58,7	70	18	335	8,62
40 H 200	15200040	2F	St	40	161,70	160,33	168	80	58,7	70	18	338	9,50
44 H 200	15200044	4F	GG	44	177,87	176,50	184	80	58,7	70	18	339	5,14
45 H 200	15200045	4F	GG	45	181,91	180,54	192	80	58,7	70	18	340	5,38
48 H 200	15200048	4F	GG	48	194,04	192,67	200	90	58,7	75	24	342	6,29
50 H 200	15200050	4	GG	50	202,13	200,75		90	58,7	75	24		6,68
52 H 200	15200052	4	GG	52	210,21	208,84		90	58,7	75	24		6,81
58 H 200	15200058	4	GG	58	234,47	233,09		90	58,7	75	24		7,26
60 H 200	15200060	4	GG	60	242,55	241,18		100	58,7	75	24		8,25
70 H 200	15200070	4	GG	70	282,98	281,61		100	58,7	75	28		9,20
72 H 200	15200072	4	GG	72	291,06	289,69		120	58,7	75	28		11,09
84 H 200	15200084	4	GG	84	339,57	338,20		120	58,7	75	28		12,63
96 H 200	15200096	4	GG	96	388,08	386,71		120	58,7	75	28		14,51
120 H 200	15200120	4	GG	120	485,10	483,73		120	58,7	75	28		19,15



# PULEGGE DENTATE PER CINGHIE POSITIVE - ISO 5294

## TIMING BELT PULLEYS - ISO 5294

### H 300

PASSO 1/2" (12,7 mm)

PER CINGHIE LARGHEZZA 3" (76,2 mm)

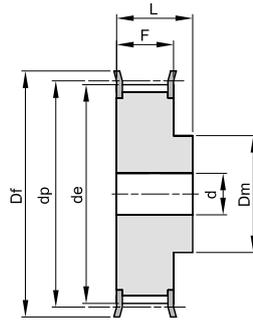

2F

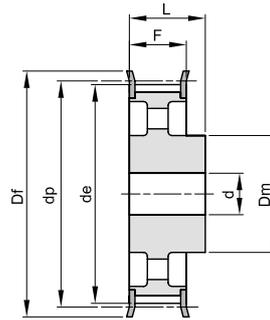

4F

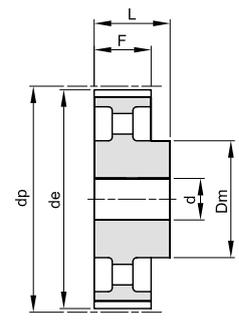

4

Materiale: Acciaio (St)  
Materiale: Ghisa (GG)

descrizione	codice	tipo	materiale	denti	dp	de	Df	Dm	F	L	d	n° flangia	Kg.
14 H 300	15300014	2F	St	14	56,59	55,22	63	40	85,7	100	18	309	1,64
15 H 300	15300015	2F	St	15	60,64	59,27	66	45	85,7	100	18	310	1,91
16 H 300	15300016	2F	St	16	64,68	63,31	71	45	85,7	100	18	311	2,16
17 H 300	15300017	2F	St	17	68,72	67,35	75	45	85,7	100	18	312	2,43
18 H 300	15300018	2F	St	18	72,77	71,39	79	55	85,7	100	18	313	2,80
19 H 300	15300019	2F	St	19	76,81	75,44	83	60	85,7	100	18	314	3,16
20 H 300	15300020	2F	St	20	80,85	79,48	87	62	85,7	100	18	315	3,50
21 H 300	15300021	2F	St	21	84,89	83,52	91	65	85,7	100	18	316	3,87
22 H 300	15300022	2F	St	22	88,94	87,56	93	68	85,7	100	18	317	4,26
23 H 300	15300023	2F	St	23	92,98	91,61	97	72	85,7	100	18	318	4,68
24 H 300	15300024	2F	St	24	97,03	95,65	103	72	85,7	100	18	320	5,08
25 H 300	15300025	2F	St	25	101,06	99,69	106	72	85,7	100	18	321	5,45
26 H 300	15300026	2F	St	26	105,11	103,73	111	80	85,7	100	18	322	6,01
27 H 300	15300027	2F	St	27	109,15	107,78	115	80	85,7	100	18	323	6,45
28 H 300	15300028	2F	St	28	113,19	111,82	119	80	85,7	100	18	325	6,91
30 H 300	15300030	2F	St	30	121,29	119,90	127	80	85,7	100	18	327	7,90
32 H 300	15300032	2F	St	32	129,36	127,99	135	80	85,7	100	18	328	8,92
33 H 300	15300033	2F	St	33	133,40	132,03	140	80	85,7	100	18	330	9,46
34 H 300	15300034	2F	St	34	137,45	136,07	143	80	85,7	100	18	331	10,04
35 H 300	15300035	2F	St	35	141,49	140,12	148	80	85,7	100	18	333	10,62
36 H 300	15300036	2F	St	36	145,53	144,16	152	80	85,7	100	18	334	11,24
38 H 300	15300038	2F	St	38	153,62	152,24	158	80	85,7	100	18	335	12,44
40 H 300	15300040	2F	St	40	161,70	160,33	168	80	85,7	100	18	338	13,80
44 H 300	15300044	4F	GG	44	177,87	176,50	184	80	85,7	100	24	339	7,22
48 H 300	15300048	4F	GG	48	194,04	192,67	200	90	85,7	100	24	342	8,60
50 H 300	15300050	4	GG	50	202,13	200,75		90	85,7	100	24		8,99
58 H 300	15300058	4	GG	58	234,47	233,09		90	85,7	100	24		10,04
60 H 300	15300060	4	GG	60	242,55	241,18		100	85,7	100	24		11,18
72 H 300	15300072	4	GG	72	291,06	289,69		120	85,7	100	28		15,07
84 H 300	15300084	4	GG	84	339,57	338,20		120	85,7	100	28		16,97
96 H 300	15300096	4	GG	96	388,08	386,71		120	85,7	100	28		19,86
120 H 300	15300120	4	GG	120	485,10	483,73		120	85,7	100	28		25,91



## PULEGGE DENTATE PER CINGHIE POSITIVE - ISO 5294 TIMING BELT PULLEYS - ISO 5294

### XH 200

PASSO 7/8" (22,22 mm)

PER CINGHIE LARGHEZZA 2" (50,8 mm)

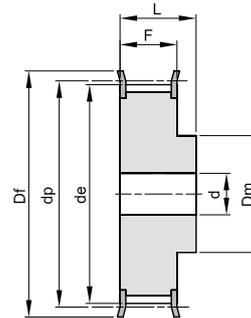

2F

Materiale: Acciaio (St)

descrizione	codice	tipo	materiale	denti	dp	de	Df	Dm	F	L	d	n° flangia	Kg.
18 XH 200	16200018	2F	St	18	127,34	124,55	138	100	65	80	24	401	6,00
19 XH 200	16200019	2F	St	19	134,41	131,62	146	100	65	80	24	402	6,60
20 XH 200	16200020	2F	St	20	141,49	138,69	154	100	65	80	24	403	7,30
21 XH 200	16200021	2F	St	21	148,56	145,77	160	110	65	80	24	404	8,73
22 XH 200	16200022	2F	St	22	155,64	152,84	168	110	65	80	24	405	9,55
24 XH 200	16200024	2F	St	24	169,79	166,99	183	120	65	80	24	406	11,47
25 XH 200	16200025	2F	St	25	176,86	174,07	188	120	65	80	24	407	12,46
26 XH 200	16200026	2F	St	26	183,93	181,14	198	120	65	80	24	409	13,47
27 XH 200	16200027	2F	St	27	191,01	188,22	200	120	65	80	24	410	14,42
28 XH 200	16200028	2F	St	28	198,09	195,29	211	120	65	80	24	411	15,44
30 XH 200	16200030	2F	St	30	212,23	209,44	226	120	65	80	24	412	17,69
32 XH 200	16200032	2F	St	32	226,38	223,59	240	120	65	80	24	414	19,95
34 XH 200	16200034	2F	St	34	240,53	237,74	256	120	65	80	24	415	22,75



## PULEGGE DENTATE PER CINGHIE POSITIVE - ISO 5294 TIMING BELT PULLEYS - ISO 5294

### XH 300

PASSO 7/8" (22,22 mm)

PER CINGHIE LARGHEZZA 3" (76,2 mm)

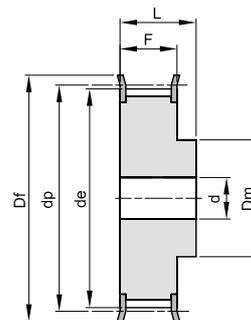

2F

Materiale: Acciaio (St)

descrizione	codice	tipo	materiale	denti	dp	de	Df	Dm	F	L	d	n° flangia	Kg.
18 XH 300	16300018	2F	St	18	127,34	124,55	138	100	92	110	28	401	8,90
19 XH 300	16300019	2F	St	19	134,41	131,62	146	100	92	110	28	402	9,20
20 XH 300	16300020	2F	St	20	141,49	138,69	154	100	92	110	28	403	10,61
21 XH 300	16300021	2F	St	21	148,56	145,77	160	110	92	110	28	404	11,87
22 XH 300	16300022	2F	St	22	155,64	152,84	168	110	92	110	28	405	13,08
24 XH 300	16300024	2F	St	24	169,79	166,99	183	120	92	110	28	406	15,77
25 XH 300	16300025	2F	St	25	176,86	174,07	188	120	92	110	28	407	17,13
26 XH 300	16300026	2F	St	26	183,93	181,14	198	120	92	110	28	409	18,55
27 XH 300	16300027	2F	St	27	191,01	188,22	200	120	92	110	28	410	19,90
28 XH 300	16300028	2F	St	28	198,09	195,29	211	150	92	110	28	411	22,27
30 XH 300	16300030	2F	St	30	212,23	209,44	226	150	92	110	28	412	25,39
32 XH 300	16300032	2F	St	32	226,38	223,59	240	150	92	110	28	414	28,73
34 XH 300	16300034	2F	St	34	240,53	237,74	256	150	92	110	28	415	34,20



# PULEGGE DENTATE PER CINGHIE POSITIVE - ISO 5294

## TIMING BELT PULLEYS - ISO 5294

### XH 400

PASSO 7/8" (22,22 mm)

PER CINGHIE LARGHEZZA 4" (101,6 mm)

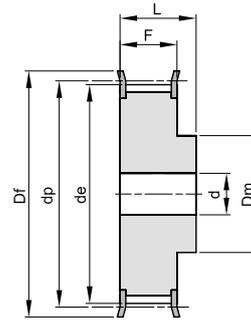

2F

Materiale: Acciaio (St)

descrizione	codice	tipo	materiale	denti	dp	de	Df	Dm	F	L	d	n° flangia	Kg.
18 XH 400	16400018	2F	St	18	127,34	124,55	138	100	119	132	32	401	9,60
19 XH 400	16400019	2F	St	19	134,41	131,62	146	100	119	132	32	402	10,80
20 XH 400	16400020	2F	St	20	141,49	138,69	154	100	119	132	32	403	12,87
21 XH 400	16400021	2F	St	21	148,56	145,77	160	110	119	132	32	404	14,42
22 XH 400	16400022	2F	St	22	155,64	152,84	168	110	119	132	32	405	15,44
24 XH 400	16400024	2F	St	24	169,79	166,99	183	120	119	132	32	406	19,22
25 XH 400	16400025	2F	St	25	176,86	174,07	188	120	119	132	32	407	21,05
26 XH 400	16400026	2F	St	26	183,93	181,14	198	120	119	132	32	409	22,80
27 XH 400	16400027	2F	St	27	191,01	188,22	200	120	119	132	32	410	24,66
28 XH 400	16400028	2F	St	28	198,09	195,29	211	150	119	132	32	411	27,23
30 XH 400	16400030	2F	St	30	212,23	209,44	226	150	119	132	32	412	31,30
32 XH 400	16400032	2F	St	32	226,38	223,59	240	150	119	132	32	414	35,20
34 XH 400	16400034	2F	St	34	240,53	237,74	256	150	119	132	32	415	40,00



# PULEGGE DENTATE A BUSSOLA CONICA PER CINGHIE POSITIVE - ISO 5294

## TIMING BELT PULLEYS FOR TAPER BUSHES - ISO 5294

### L 050

PASSO 3/8" (9,525 mm)

PER CINGHIE LARGHEZZA 1/2" (12,7 mm)

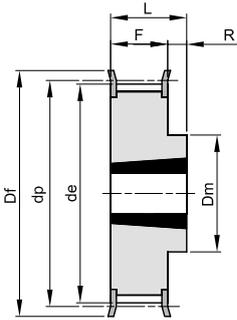

10F

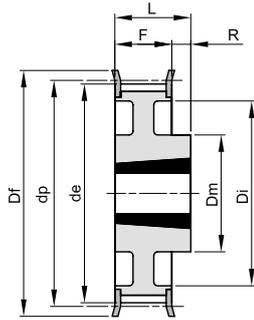

11F

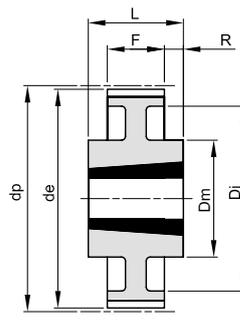

13

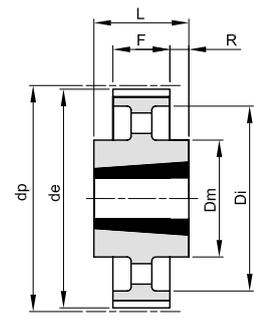

14

Materiale: Acciaio (St)  
Materiale: Ghisa (GG)

descrizione	codice	tipo	materiale	denti	bussola	foro max	dp	de	Df	Dm	Di	F	L	R	n° flangia	Kg.
TL 18 L 050	21050018	10F	St	18	1108	28	54,57	53,81	60	45		19,0	22,0	3	308	0,20
TL 19 L 050	21050019	10F	St	19	1108	28	57,61	56,84	63	45		19,0	22,0	3	309	0,23
TL 20 L 050	21050020	10F	St	20	1108	28	60,64	59,88	66	48		19,0	22,0	3	310	0,27
TL 21 L 050	21050021	10F	St	21	1108	28	63,67	62,91	71	48		19,0	22,0	3	311	0,30
TL 22 L 050	21050022	10F	St	22	1108	28	66,70	65,94	75	51		19,0	22,0	3	312	0,34
TL 23 L 050	21050023	10F	St	23	1108	28	69,73	68,97	79	54		19,0	22,0	3	313	0,40
TL 24 L 050	21050024	10F	St	24	1108	28	72,77	72,00	79	54		19,0	22,0	3	313	0,45
TL 25 L 050	21050025	10F	St	25	1108	28	75,80	75,04	83	56		19,0	22,0	3	314	0,50
TL 26 L 050	21050026	10F	St	26	1108	28	78,83	78,07	87	60		19,0	22,0	3	315	0,55
TL 27 L 050	21050027	10F	St	27	1108	28	81,86	81,10	87	62		19,0	22,0	3	315	0,60
TL 28 L 050	21050028	10F	St	28	1108	28	84,89	84,13	91	65		19,0	22,0	3	316	0,65
TL 30 L 050	21050030	10F	St	30	1108	28	90,96	90,20	97	70		19,0	22,0	3	318	0,80
TL 32 L 050	21050032	10F	St	32	1108	28	97,02	96,26	103	74		19,0	22,0	3	320	0,98
TL 36 L 050	21050036	10F	St	36	1108	28	109,15	108,39	115	85		19,0	22,0	3	323	1,20
TL 40 L 050	21050040	10F	St	40	1610	42	121,28	120,51	127	97		19,0	25,0	6	327	1,40
TL 48 L 050	21050048	11F	St	48	1610	42	145,53	144,77	152	88	120	19,0	25,0	6	334	2,30
TL 60 L 050	21050060	13	St	60	1610	42	181,91	181,15		92	166	19,0	25,0	3		2,20
TL 72 L 050	21050072	14	GG	72	1610	42	218,30	217,53		92	202	19,0	25,0	3		2,10
TL 84 L 050	21050084	14	GG	84	1610	42	254,68	253,90		92	236	19,0	25,0	3		2,46
TL 96 L 050	21050096	14	GG	96	2012	50	291,06	290,30		106	270	19,0	32,0	6,5		3,36
TL120 L 050	21050120	14	GG	120	2012	50	363,83	363,07		106	343	19,0	32,0	6,5		4,44



# PULEGGE DENTATE A BUSSOLA CONICA PER CINGHIE POSITIVE - ISO 5294

## TIMING BELT PULLEYS FOR TAPER BUSHES - ISO 5294

### L 075

PASSO 3/8" (9,525 mm)

PER CINGHIE LARGHEZZA 3/4" (19,05 mm)

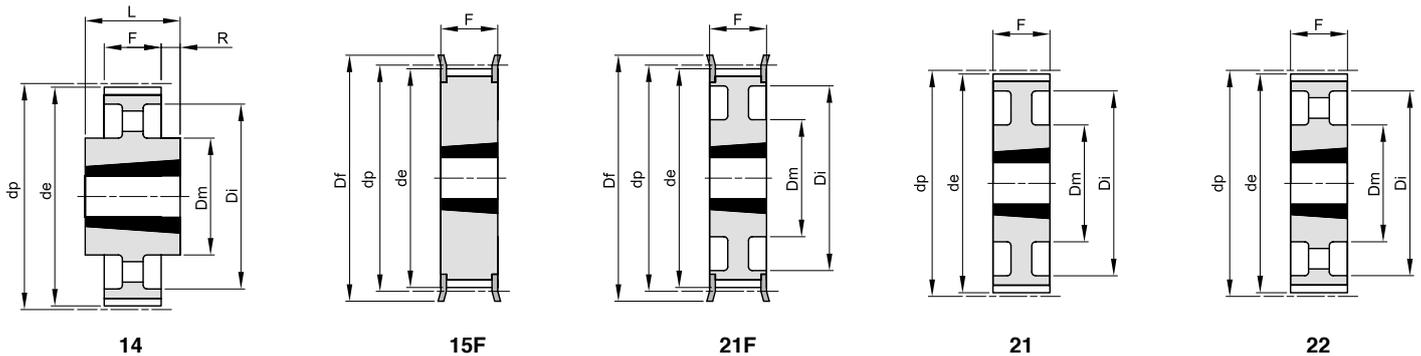

Materiale: Acciaio (St)  
Materiale: Ghisa (GG)

descrizione	codice	tipo	materiale	denti	bussola	foro max	dp	de	Df	Dm	Di	F	L	R	n° flangia	Kg.
TL 18 L 075	21075018	15F	St	18	1108	28	54,57	53,81	60			25,0	25,0		308	0,25
TL 19 L 075	21075019	15F	St	19	1108	28	57,61	56,84	63			25,0	25,0		309	0,32
TL 20 L 075	21075020	15F	St	20	1108	28	60,64	59,88	66			25,0	25,0		310	0,35
TL 21 L 075	21075021	15F	St	21	1108	28	63,67	62,91	71			25,0	25,0		311	0,40
TL 22 L 075	21075022	15F	St	22	1108	28	66,70	65,94	75			25,0	25,0		312	0,44
TL 23 L 075	21075023	15F	St	23	1108	28	69,73	68,97	79			25,0	25,0		313	0,48
TL 24 L 075	21075024	15F	St	24	1108	28	72,77	72,00	79			25,0	25,0		313	0,55
TL 25 L 075	21075025	15F	St	25	1108	28	75,80	75,04	83			25,0	25,0		314	0,63
TL 26 L 075	21075026	15F	St	26	1108	28	78,83	78,07	87			25,0	25,0		315	0,66
TL 27 L 075	21075027	15F	St	27	1108	28	81,86	81,10	87			25,0	25,0		315	0,70
TL 28 L 075	21075028	15F	St	28	1108	28	84,89	84,13	91			25,0	25,0		316	0,72
TL 30 L 075	21075030	15F	St	30	1108	28	90,96	90,20	97			25,0	25,0		318	0,93
TL 32 L 075	21075032	15F	St	32	1108	28	97,02	96,26	103			25,0	25,0		320	1,10
TL 36 L 075	21075036	15F	St	36	1610	42	109,15	108,39	115			25,0	25,0		323	1,20
TL 40 L 075	21075040	15F	St	40	1610	42	121,28	120,51	127			25,0	25,0		327	1,70
TL 48 L 075	21075048	21F	St	48	1610	42	145,53	144,77	152	92	120	25,0	25,0		334	2,60
TL 60 L 075	21075060	21	St	60	1610	42	181,91	181,15		92	166	25,0	25,0			3,00
TL 72 L 075	21075072	22	GG	72	1610	42	218,30	217,53		92	202	25,0	25,0			2,33
TL 84 L 075	21075084	14	GG	84	2012	50	254,68	253,90		106	236	25,0	32,0	3,5		3,55
TL 96 L 075	21075096	14	GG	96	2012	50	291,06	290,30		106	270	25,0	32,0	3,5		3,95
TL120 L 075	21075120	14	GG	120	2012	50	363,83	363,07		106	343	25,0	32,0	3,5		5,61



# PULEGGE DENTATE A BUSSOLA CONICA PER CINGHIE POSITIVE - ISO 5294

## TIMING BELT PULLEYS FOR TAPER BUSHES - ISO 5294

### L 100

PASSO 3/8" (9,525 mm)

PER CINGHIE LARGHEZZA 1" (25,4 mm)

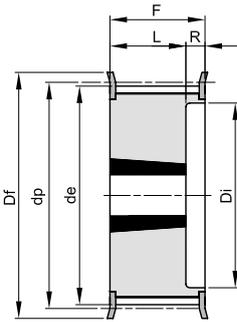

16F

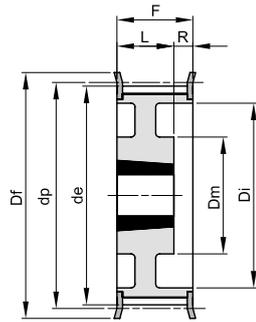

17F

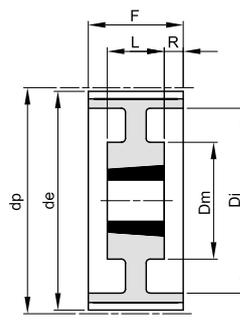

19

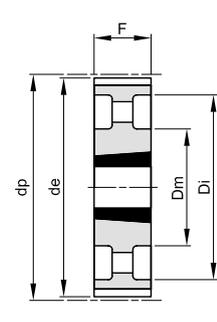

22

Materiale: Acciaio (St)  
Materiale: Ghisa (GG)

descrizione	codice	tipo	materiale	denti	bussola	foro max	dp	de	Df	Dm	Di	F	L	R	n° flangia	Kg.
TL 18 L 100	21100018	16F	St	18	1108	28	54,57	53,81	60		38	31,0	22,0	9,0	308	0,20
TL 19 L 100	21100019	16F	St	19	1108	28	57,61	56,84	63		38	31,0	22,0	9,0	309	0,32
TL 20 L 100	21100020	16F	St	20	1108	28	60,64	59,88	66		45	31,0	22,0	9,0	310	0,41
TL 21 L 100	21100021	16F	St	21	1108	28	63,67	62,91	71		45	31,0	22,0	9,0	311	0,45
TL 22 L 100	21100022	16F	St	22	1108	28	66,70	65,94	75		48	31,0	22,0	9,0	312	0,47
TL 23 L 100	21100023	16F	St	23	1108	28	69,73	68,97	79		52	32,0	22,0	10,0	313	0,50
TL 24 L 100	21100024	16F	St	24	1108	28	72,77	72,00	79		52	32,0	22,0	10,0	313	0,64
TL 25 L 100	21100025	16F	St	25	1108	28	75,80	75,04	83		54	32,0	22,0	10,0	314	0,68
TL 26 L 100	21100026	16F	St	26	1108	28	78,83	78,07	87		60	32,0	22,0	10,0	315	0,70
TL 27 L 100	21100027	16F	St	27	1108	28	81,86	81,10	87		60	32,0	22,0	10,0	315	0,83
TL 28 L 100	21100028	16F	St	28	1108	28	84,89	84,13	91		65	32,0	22,0	10,0	316	0,85
TL 30 L 100	21100030	16F	St	30	1210	32	90,96	90,20	97		71	32,0	25,0	7,0	318	0,90
TL 32 L 100	21100032	16F	St	32	1210	32	97,02	96,26	103		75	32,0	25,0	7,0	320	1,05
TL 36 L 100	21100036	16F	St	36	1610	42	109,15	108,39	115		86	32,0	25,0	7,0	323	1,40
TL 40 L 100	21100040	16F	St	40	1610	42	121,28	120,51	127		96	32,0	25,0	7,0	327	1,65
TL 48 L 100	21100048	17F	St	48	1610	42	145,53	144,77	152	92	120	32,0	25,0	7,0	334	2,80
TL 60 L 100	21100060	19	St	60	1610	42	181,91	181,15		92	166	32,0	25,0	3,5		2,70
TL 72 L 100	21100072	22	GG	72	2012	50	218,30	217,53		106	202	32,0	32,0			2,96
TL 84 L 100	21100084	22	GG	84	2012	50	254,68	253,90		106	236	32,0	32,0			3,87
TL 96 L 100	21100096	22	GG	96	2012	50	291,06	290,30		106	270	32,0	32,0			4,64
TL120 L 100	21100120	22	GG	120	2012	50	363,83	363,07		106	343	32,0	32,0			6,37



# PULEGGE DENTATE A BUSSOLA CONICA PER CINGHIE POSITIVE - ISO 5294

## TIMING BELT PULLEYS FOR TAPER BUSHES - ISO 5294

### H 100

PASSO 1/2" (12,7 mm)

PER CINGHIE LARGHEZZA 1" (25,4 mm)

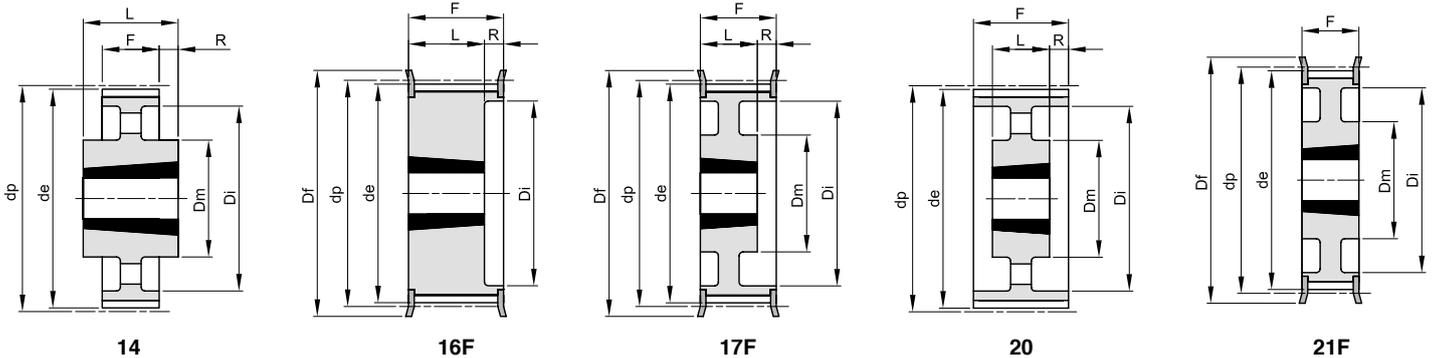

Materiale: Acciaio (St)  
Materiale: Ghisa (GG)

descrizione	codice	tipo	materiale	denti	bussola	foro max	dp	de	Df	Dm	Di	F	L	R	n° flangia	Kg.
TL 16 H 100	22100016	16F	St	16	1108	28	64,68	63,31	71	45	31,0	22,0	9,0	311	0,42	
TL 18 H 100	22100018	16F	St	18	1210	32	72,77	71,39	79	52	31,0	25,0	6,0	313	0,49	
TL 19 H 100	22100019	16F	St	19	1210	32	76,81	75,44	83	56	31,0	25,0	6,0	314	0,62	
TL 20 H 100	22100020	16F	St	20	1210	32	80,85	79,48	87	60	31,0	25,0	6,0	315	0,73	
TL 21 H 100	22100021	16F	St	21	1210	32	84,89	83,52	91	64	32,0	25,0	7,0	316	0,80	
TL 22 H 100	22100022	16F	St	22	1210	32	88,94	87,56	93	67	32,0	25,0	7,0	317	0,94	
TL 23 H 100	22100023	16F	St	23	1610	42	92,98	91,61	97	70	32,0	25,0	7,0	318	0,97	
TL 24 H 100	22100024	16F	St	24	1610	42	97,02	95,65	103	73,5	32,0	25,0	7,0	320	1,05	
TL 25 H 100	22100025	16F	St	25	1610	42	101,06	99,69	106	77	32,0	25,0	7,0	321	1,10	
TL 26 H 100	22100026	16F	St	26	1610	42	105,11	103,73	111	82	32,0	25,0	7,0	322	1,20	
TL 27 H 100	22100027	16F	St	27	1610	42	109,15	107,78	115	85	32,0	25,0	7,0	323	1,35	
TL 28 H 100	22100028	16F	St	28	1610	42	113,19	111,82	119	90,5	32,0	25,0	7,0	325	1,50	
TL 30 H 100	22100030	16F	St	30	1610	42	121,28	119,90	127	98	32,0	25,0	7,0	327	1,78	
TL 32 H 100	22100032	17F	St	32	1610	42	129,36	127,99	135	90	106	32,0	25,0	7,0	328	2,05
TL 36 H 100	22100036	17F	St	36	1610	42	145,53	144,16	152	92	121	32,0	25,0	7,0	334	2,80
TL 40 H 100	22100040	17F	St	40	1610	42	161,70	160,33	168	92	138	32,0	25,0	7,0	338	3,65
TL 44 H 100	22100044	21F	St	44	2012	50	177,87	176,50	184	106	152	32,0	32,0		339	3,86
TL 48 H 100	22100048	21F	St	48	2012	50	194,04	192,67	200	106	169	32,0	32,0		342	4,20
TL 60 H 100	22100060	20	GG	60	2012	50	242,55	241,18		106	223	34,0	32,0	1,0		3,76
TL 72 H 100	22100072	20	GG	72	2012	50	291,06	289,69		106	270	34,0	32,0	1,0		4,88
TL 84 H 100	22100084	20	GG	84	2012	50	339,57	338,20		106	318	34,0	32,0	1,0		6,12
TL 96 H 100	22100096	14	GG	96	2517	60	388,08	386,71		119	366	34,0	45,0	5,5		7,95
TL120 H 100	22100120	14	GG	120	2517	60	485,10	483,73		119	462	34,0	45,0	5,5		10,05



# PULEGGE DENTATE A BUSSOLA CONICA PER CINGHIE POSITIVE - ISO 5294

## TIMING BELT PULLEYS FOR TAPER BUSHES - ISO 5294

### H 150

PASSO 1/2" (12,7 mm)

PER CINGHIE LARGHEZZA 1 1/2 (38,1 mm)

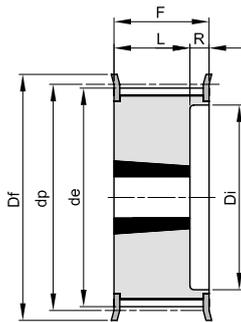

16F

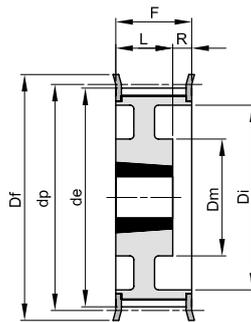

17F

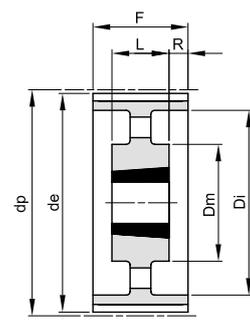

20

Materiale: Acciaio (St)  
Materiale: Ghisa (GG)

descrizione	codice	tipo	materiale	denti	bussola	foro max	dp	de	Df	Dm	Di	F	L	R	n° flangia	Kg.
TL 18 H 150	22150018	16F	St	18	1210	32	72,77	71,39	79		52	45,0	25,0	20,0	313	0,60
TL 19 H 150	22150019	16F	St	19	1210	32	76,81	75,44	83		56	45,0	25,0	20,0	314	0,72
TL 20 H 150	22150020	16F	St	20	1210	32	80,85	79,48	87		60	45,0	25,0	20,0	315	0,83
TL 21 H 150	22150021	16F	St	21	1210	32	84,89	83,52	91		64	45,0	25,0	20,0	316	1,00
TL 22 H 150	22150022	16F	St	22	1210	32	88,94	87,56	93		67	45,0	25,0	20,0	317	1,25
TL 23 H 150	22150023	16F	St	23	1610	42	92,98	91,61	97		70	45,0	25,0	20,0	318	1,05
TL 24 H 150	22150024	16F	St	24	1610	42	97,02	95,65	103		73,5	45,0	25,0	20,0	320	1,10
TL 25 H 150	22150025	16F	St	25	1610	42	101,06	99,69	106		77	45,0	25,0	20,0	321	1,30
TL 26 H 150	22150026	16F	St	26	1610	42	105,11	103,73	111		82	45,0	25,0	20,0	322	1,42
TL 27 H 150	22150027	16F	St	27	1610	42	109,15	107,78	115		85	45,0	25,0	20,0	323	1,65
TL 28 H 150	22150028	16F	St	28	1610	42	113,19	111,82	119		90,5	45,0	25,0	20,0	325	1,88
TL 30 H 150	22150030	16F	St	30	1610	42	121,28	119,90	127		98	45,0	25,0	20,0	327	2,05
TL 32 H 150	22150032	17F	St	32	1610	42	129,36	127,99	135	90	106	45,0	25,0	20,0	328	2,35
TL 36 H 150	22150036	17F	St	36	1610	42	145,53	144,16	152	92	121	45,0	25,0	20,0	334	3,20
TL 40 H 150	22150040	17F	St	40	1610	42	161,70	160,33	168	92	138	45,0	25,0	20,0	338	4,10
TL 44 H 150	22150044	17F	St	44	2012	50	177,87	176,50	184	106	152	45,0	32,0	13,0	339	4,50
TL 48 H 150	22150048	17F	St	48	2012	50	194,04	192,67	200	106	169	45,0	32,0	13,0	342	4,80
TL 60 H 150	22150060	20	GG	60	2012	50	242,55	241,18		106	223	46,0	32,0	7,0		4,51
TL 72 H 150	22150072	20	GG	72	2012	50	291,06	289,69		106	270	46,0	32,0	7,0		6,16
TL 84 H 150	22150084	20	GG	84	2012	50	339,57	338,20		106	320	46,0	32,0	7,0		7,40
TL 96 H 150	22150096	20	GG	96	2517	60	388,08	386,71		119	366	46,0	45,0	0,5		9,87
TL120 H 150	22150120	20	GG	120	2517	60	485,10	483,73		119	462	46,0	45,0	0,5		13,50



# PULEGGE DENTATE A BUSSOLA CONICA PER CINGHIE POSITIVE - ISO 5294

## TIMING BELT PULLEYS FOR TAPER BUSHES - ISO 5294

### H 200

PASSO 1/2" (12,7 mm)

PER CINGHIE LARGHEZZA 2" (50,8 mm)

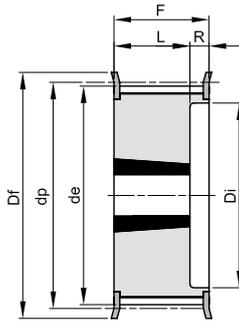

16F

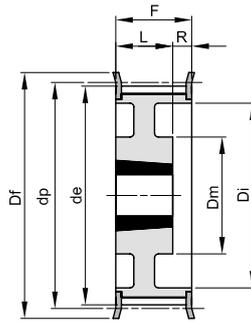

17F

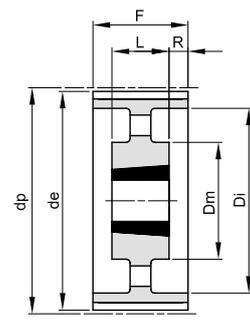

20

Materiale: Acciaio (St)  
Materiale: Ghisa (GG)

descrizione	codice	tipo	materiale	denti	bussola	foro max	dp	de	Df	Dm	Di	F	L	R	n° flangia	Kg.
TL 18 H 200	22200018	16F	St	18	1210	32	72,77	71,39	79		52	58,0	25,0	33,0	313	0,84
TL 19 H 200	22200019	16F	St	19	1210	32	76,81	75,44	83		56	58,0	25,0	33,0	314	0,96
TL 20 H 200	22200020	16F	St	20	1610	42	80,85	79,48	87		60	58,0	25,0	33,0	315	0,93
TL 21 H 200	22200021	16F	St	21	1610	42	84,89	83,52	91		64	58,0	25,0	33,0	316	1,07
TL 22 H 200	22200022	16F	St	22	1610	42	88,94	87,56	93		67	58,0	25,0	33,0	317	1,25
TL 23 H 200	22200023	16F	St	23	1610	42	92,98	91,61	97		70	58,0	25,0	33,0	318	1,40
TL 24 H 200	22200024	16F	St	24	1610	42	97,02	95,65	103		73,5	58,0	25,0	33,0	320	1,55
TL 25 H 200	22200025	16F	St	25	1610	42	101,06	99,69	106		77	58,0	25,0	33,0	321	1,71
TL 26 H 200	22200026	16F	St	26	1610	42	105,11	103,73	111		82	58,0	25,0	33,0	322	1,84
TL 27 H 200	22200027	16F	St	27	1610	42	109,15	107,78	115		85	58,0	25,0	33,0	323	2,06
TL 28 H 200	22200028	16F	St	28	1610	42	113,19	111,82	119		90,5	58,0	25,0	33,0	325	2,17
TL 30 H 200	22200030	16F	St	30	1610	42	121,28	119,90	127		98	58,0	25,0	33,0	327	2,60
TL 32 H 200	22200032	16F	St	32	2012	50	129,36	127,99	135		106	58,0	32,0	26,0	328	2,95
TL 36 H 200	22200036	17F	St	36	2012	50	145,53	144,16	152	102	121	58,0	32,0	26,0	334	3,62
TL 40 H 200	22200040	17F	St	40	2012	50	161,70	160,33	168	106	138	58,0	32,0	26,0	338	4,33
TL 44 H 200	22200044	17F	St	44	2012	50	177,87	176,50	184	106	152	58,0	32,0	26,0	339	5,33
TL 48 H 200	22200048	17F	St	48	2517	60	194,04	192,67	200	119	169	58,0	45,0	13,0	342	6,47
TL 60 H 200	22200060	20	GG	60	2517	60	242,55	241,18		119	223	60,0	45,0	7,5		5,86
TL 72 H 200	22200072	20	GG	72	2517	60	291,06	289,69		119	270	60,0	45,0	7,5		7,42
TL 84 H 200	22200084	20	GG	84	2517	60	339,57	338,20		119	320	60,0	45,0	7,5		8,73
TL 96 H 200	22200096	20	GG	96	2517	60	388,08	386,71		119	366	60,0	45,0	7,5		10,83
TL120 H 200	22200120	20	GG	120	2517	60	485,10	483,73		119	462	60,0	45,0	7,5		14,95



# PULEGGE DENTATE A BUSSOLA CONICA PER CINGHIE POSITIVE - ISO 5294

## TIMING BELT PULLEYS FOR TAPER BUSHES - ISO 5294

### H 300

PASSO 1/2" (12,7 mm)

PER CINGHIE LARGHEZZA 3" (76,2 mm)

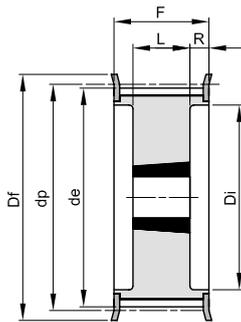

18F

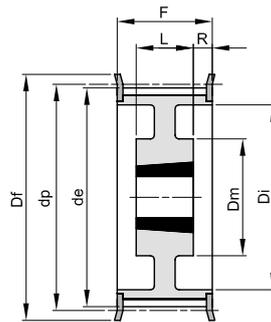

19F

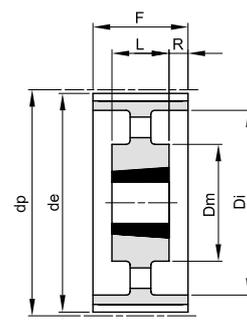

20

Materiale: Acciaio (St)  
Materiale: Ghisa (GG)

descrizione	codice	tipo	materiale	denti	bussola	foro max	dp	de	Df	Dm	Di	F	L	R	n° flangia	Kg.
TL 20 H 300	22300020	18F	St	20	1615	42	80,85	79,48	87		64,5	84,0	38,0	23,0	315	1,22
TL 21 H 300	22300021	18F	St	21	1615	42	84,89	83,52	91		65	84,0	38,0	23,0	316	1,52
TL 22 H 300	22300022	18F	St	22	1615	42	88,94	87,56	93		67	84,0	38,0	23,0	317	1,80
TL 23 H 300	22300023	18F	St	23	1615	42	92,98	91,61	97		70	84,0	38,0	23,0	318	2,04
TL 24 H 300	22300024	18F	St	24	1615	42	97,02	95,65	103		73,5	84,0	38,0	23,0	320	2,29
TL 25 H 300	22300025	18F	St	25	1615	42	101,06	99,69	106		77	84,0	38,0	23,0	321	2,54
TL 26 H 300	22300026	18F	St	26	1615	42	105,11	103,73	111		82	84,0	38,0	23,0	322	2,73
TL 27 H 300	22300027	18F	St	27	2012	50	109,15	107,78	115		85	84,0	32,0	26,0	323	2,54
TL 28 H 300	22300028	18F	St	28	2012	50	113,19	111,82	119		90,5	84,0	32,0	26,0	325	2,68
TL 30 H 300	22300030	18F	St	30	2012	50	121,28	119,90	127		98	84,0	32,0	26,0	327	3,21
TL 32 H 300	22300032	18F	St	32	2517	60	129,36	127,99	135		106	84,0	45,0	19,5	328	3,58
TL 36 H 300	22300036	18F	St	36	2517	60	145,53	144,16	152		121	84,0	45,0	19,5	334	4,99
TL 40 H 300	22300040	18F	St	40	2517	60	161,70	160,33	168		138	84,0	45,0	19,5	338	6,50
TL 44 H 300	22300044	19F	St	44	2517	60	177,87	176,50	184	119	152	86,0	45,0	20,5	339	7,55
TL 48 H 300	22300048	19F	St	48	2517	60	194,04	192,67	200	119	169	86,0	45,0	20,5	342	8,66
TL 60 H 300	22300060	20	GG	60	2517	60	242,55	241,18		119	223	86,0	45,0	20,5		7,42
TL 72 H 300	22300072	20	GG	72	2517	60	291,06	289,69		119	270	86,0	45,0	20,5		9,33
TL 84 H 300	22300084	20	GG	84	2517	60	339,57	338,20		119	320	86,0	45,0	20,5		11,19
TL 96 H 300	22300096	20	GG	96	3030	75	388,08	386,71		150	362	86,0	76,0	5,0		17,96
TL120 H 300	22300120	20	GG	120	3030	75	485,10	483,73		150	460	86,0	76,0	5,0		22,23



# PULEGGE DENTATE PER CINGHIE HTD®

## HTD® TIMING BELT PULLEYS

### 3M

#### PASSO 3 mm

PER CINGHIE LARGHEZZA 9 mm

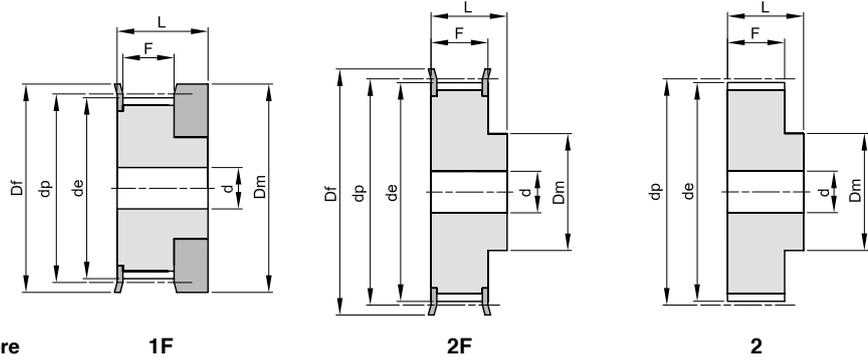

Materiale: Alluminio UNI 9006 - T6 (Al)  
adatto per l'ossidazione dura a spessore

descrizione	codice	tipo	materiale	denti	dp	de	Df	Dm	Di	F	L	d	n° flangia	Kg.
10 3M 09	40009010	1F	Al	10	9,55	8,79	13,0	12,0		10,2	17,5		100	0,01
12 3M 09	40009012	1F	Al	12	11,46	10,70	15,0	15,0		10,2	17,5		101	0,01
14 3M 09	40009014	1F	Al	14	13,37	12,61	16,0	16,0		10,2	17,5		102	0,01
15 3M 09	40009015	1F	Al	15	14,32	13,56	18,0	17,5		10,2	17,5		104	0,01
16 3M 09	40009016	2F	Al	16	15,28	14,52	18,0	10,0		12,8	20,6		104	0,01
18 3M 09	40009018	2F	Al	18	17,19	16,43	19,5	11,0		12,8	20,6	6	105	0,01
20 3M 09	40009020	2F	Al	20	19,10	18,34	23,0	13,0		12,8	20,6	6	107	0,01
21 3M 09	40009021	2F	Al	21	20,05	19,29	25,0	14,0		12,8	20,6	6	108	0,01
22 3M 09	40009022	2F	Al	22	21,01	20,25	25,0	14,0		12,8	20,6	6	108	0,01
24 3M 09	40009024	2F	Al	24	22,92	22,16	25,0	14,0		12,8	20,6	6	108	0,02
26 3M 09	40009026	2F	Al	26	24,83	24,07	28,0	16,0		12,8	20,6	6	109	0,02
28 3M 09	40009028	2F	Al	28	26,74	25,98	32,0	18,0		12,8	20,6	6	110	0,02
30 3M 09	40009030	2F	Al	30	28,65	27,89	32,0	20,0		12,8	20,6	6	110	0,03
32 3M 09	40009032	2F	Al	32	30,56	29,80	36,0	22,0		12,8	20,6	6	111	0,03
36 3M 09	40009036	2F	Al	36	34,38	33,62	38,0	26,0		13,4	22,2	6	112	0,05
40 3M 09	40009040	2F	Al	40	38,20	37,44	42,0	28,0		13,4	22,2	6	113	0,06
44 3M 09	40009044	2F	Al	44	42,02	41,26	48,0	33,0		13,4	22,2	6	114	0,07
48 3M 09	40009048	2	Al	48	45,84	45,08		33,0		13,4	22,2	8		0,11
60 3M 09	40009060	2	Al	60	57,30	56,54		33,0		13,4	22,2	8		0,11
72 3M 09	40009072	2	Al	72	68,76	68,00		33,0		13,4	22,2	8		0,15



# PULEGGE DENTATE PER CINGHIE HTD®

## HTD® TIMING BELT PULLEYS

### 3M

#### PASSO 3 mm

PER CINGHIE LARGHEZZA 15 mm

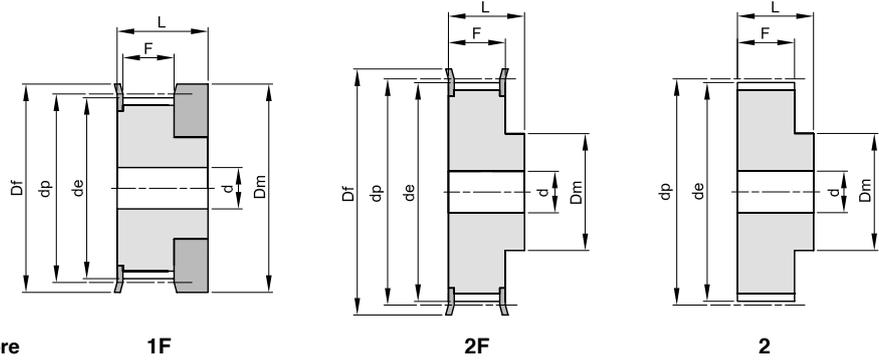

Materiale: Alluminio UNI 9006 - T6 (Al)  
adatto per l'ossidazione dura a spessore

descrizione	codice	tipo	materiale	denti	dp	de	Df	Dm	Di	F	L	d	n° flangia	Kg.
10 3M 15	40015010	1F	Al	10	9,55	8,79	13,0	12,0		17,0	26,0		100	0,01
12 3M 15	40015012	1F	Al	12	11,46	10,70	15,0	15,0		17,0	26,0		101	0,01
14 3M 15	40015014	1F	Al	14	13,37	12,61	16,0	16,0		17,0	26,0		102	0,01
15 3M 15	40015015	1F	Al	15	14,32	13,56	18,0	17,5		17,0	26,0		104	0,01
16 3M 15	40015016	2F	Al	16	15,28	14,52	18,0	10,0		19,5	26,0		104	0,01
18 3M 15	40015018	2F	Al	18	17,19	16,43	19,5	11,0		19,5	26,0	6	105	0,01
20 3M 15	40015020	2F	Al	20	19,10	18,34	23,0	13,0		19,5	26,0	6	107	0,01
21 3M 15	40015021	2F	Al	21	20,05	19,29	25,0	14,0		19,5	26,0	6	108	0,02
22 3M 15	40015022	2F	Al	22	21,01	20,25	25,0	14,0		19,5	26,0	6	108	0,02
24 3M 15	40015024	2F	Al	24	22,92	22,16	25,0	14,0		19,5	26,0	6	108	0,02
26 3M 15	40015026	2F	Al	26	24,83	24,07	28,0	16,0		19,5	26,0	6	109	0,03
28 3M 15	40015028	2F	Al	28	26,74	25,98	32,0	18,0		19,5	26,0	6	110	0,03
30 3M 15	40015030	2F	Al	30	28,65	27,89	32,0	20,0		19,5	26,0	6	110	0,04
32 3M 15	40015032	2F	Al	32	30,56	29,80	36,0	22,0		19,5	26,0	6	111	0,04
36 3M 15	40015036	2F	Al	36	34,38	33,62	38,0	26,0		20,0	30,0	6	112	0,06
40 3M 15	40015040	2F	Al	40	38,20	37,44	42,0	28,0		20,0	30,0	6	113	0,08
44 3M 15	40015044	2F	Al	44	42,02	41,26	48,0	33,0		20,0	30,0	6	114	0,10
48 3M 15	40015048	2	Al	48	45,84	45,08		33,0		20,0	30,0	8		0,10
60 3M 15	40015060	2	Al	60	57,30	56,54		33,0		20,0	30,0	8		0,15
72 3M 15	40015072	2	Al	72	68,76	68,00		33,0		20,0	30,0	8		0,21



# PULEGGE DENTATE PER CINGHIE HTD®

## HTD® TIMING BELT PULLEYS

### 5M

#### PASSO 5 mm

PER CINGHIE LARGHEZZA 9 mm

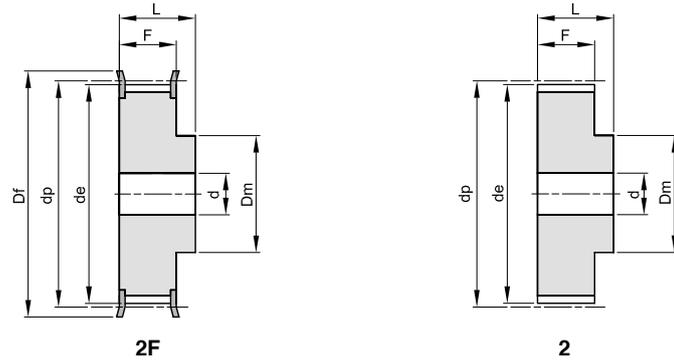

Materiale: Acciaio (St)  
 Materiale: Alluminio UNI 9006 - T6 (Al)  
 adatto per l'ossidazione dura a spessore

descrizione	codice	tipo	materiale	denti	dp	de	Df	Dm	Di	F	L	d	n° flangia	Kg.
12 5M 09	41009012	2F	St	12	19,10	17,96	23	12,5		14,5	20,0	6	202	0,03
14 5M 09	41009014	2F	St	14	22,28	21,14	25	13,5		14,5	20,0	6	203	0,04
15 5M 09	41009015	2F	St	15	23,87	22,73	28	16,0		14,5	20,0	6	204	0,05
16 5M 09	41009016	2F	St	16	25,46	24,32	28	16,5		14,5	20,0	6	204	0,05
18 5M 09	41009018	2F	St	18	28,65	27,51	32	20,0		14,5	20,0	6	205	0,07
20 5M 09	41009020	2F	St	20	31,83	30,69	36	23,0		14,5	22,5	6	206	0,10
21 5M 09	41009021	2F	St	21	33,42	32,28	38	24,0		14,5	22,5	6	207	0,12
22 5M 09	41009022	2F	St	22	35,01	33,87	38	25,5		14,5	22,5	6	207	0,13
24 5M 09	41009024	2F	St	24	38,20	37,06	42	27,0		14,5	22,5	6	208	0,15
26 5M 09	41009026	2F	St	26	41,38	40,24	44	30,0		14,5	22,5	6	209	0,18
28 5M 09	41009028	2F	St	28	44,56	43,42	48	30,5		14,5	22,5	6	210	0,21
30 5M 09	41009030	2F	St	30	47,75	46,60	51	35,0		14,5	22,5	6	211	0,25
32 5M 09	41009032	2F	St	32	50,93	49,79	54	38,0		14,5	22,5	8	212	0,28
36 5M 09	41009036	2F	St	36	57,30	56,16	60	38,0		14,5	22,5	8	214	0,33
40 5M 09	41009040	2F	St	40	63,66	62,52	71	38,0		14,5	22,5	8	217	0,42
44 5M 09	41009044	2	Al	44	70,03	68,89		38,0		14,5	25,5	8		0,17
48 5M 09	41009048	2	Al	48	76,39	75,25		45,0		14,5	25,5	8		0,18
60 5M 09	41009060	2	Al	60	95,49	94,35		45,0		14,5	25,5	8		0,23
72 5M 09	41009072	2	Al	72	114,59	113,45		45,0		14,5	25,5	8		0,42



# PULEGGE DENTATE PER CINGHIE HTD®

## HTD® TIMING BELT PULLEYS

### 5M

#### PASSO 5 mm

PER CINGHIE LARGHEZZA 15 mm

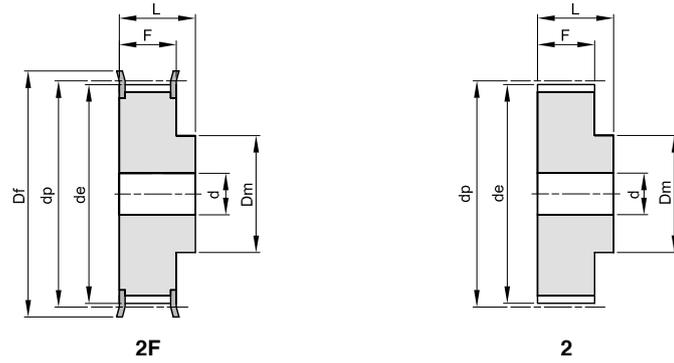

Materiale: Acciaio (St)  
 Materiale: Alluminio UNI 9006 - T6 (Al)  
 adatto per l'ossidazione dura a spessore

descrizione	codice	tipo	materiale	denti	dp	de	Df	Dm	Di	F	L	d	n° flangia	Kg.
12 5M 15	41015012	2F	St	12	19,10	17,96	23	12,5		20,5	26	6	202	0,03
14 5M 15	41015014	2F	St	14	22,28	21,14	25	13,5		20,5	26	6	203	0,04
15 5M 15	41015015	2F	St	15	23,87	22,73	28	16,0		20,5	26	6	204	0,05
16 5M 15	41015016	2F	St	16	25,46	24,32	28	16,5		20,5	26	6	204	0,06
18 5M 15	41015018	2F	St	18	28,65	27,51	32	20,0		20,5	26	6	205	0,09
20 5M 15	41015020	2F	St	20	31,83	30,69	36	23,0		20,5	26	6	206	0,12
21 5M 15	41015021	2F	St	21	33,42	32,28	38	24,0		20,5	26	6	207	0,14
22 5M 15	41015022	2F	St	22	35,01	33,87	38	25,5		20,5	26	6	207	0,15
24 5M 15	41015024	2F	St	24	38,20	37,06	42	27,0		20,5	28	6	208	0,19
26 5M 15	41015026	2F	St	26	41,38	40,24	44	30,0		20,5	28	6	209	0,23
28 5M 15	41015028	2F	St	28	44,56	43,42	48	30,5		20,5	28	6	210	0,26
30 5M 15	41015030	2F	St	30	47,75	46,60	51	35,0		20,5	28	6	211	0,32
32 5M 15	41015032	2F	St	32	50,93	49,79	54	38,0		20,5	28	8	212	0,35
36 5M 15	41015036	2F	St	36	57,30	56,16	60	38,0		20,5	28	8	214	0,43
40 5M 15	41015040	2F	St	40	63,66	62,52	71	38,0		20,5	28	8	217	0,52
44 5M 15	41015044	2	Al	44	70,03	68,89		38,0		20,5	30	8		0,23
48 5M 15	41015048	2	Al	48	76,39	75,25		38,0		20,5	30	8		0,29
60 5M 15	41015060	2	Al	60	95,49	94,35		50,0		20,5	30	8		0,42
72 5M 15	41015072	2	Al	72	114,59	113,45		50,0		20,5	30	8		0,59



# PULEGGE DENTATE PER CINGHIE HTD®

## HTD® TIMING BELT PULLEYS

### 5M

#### PASSO 5 mm

PER CINGHIE LARGHEZZA 25 mm

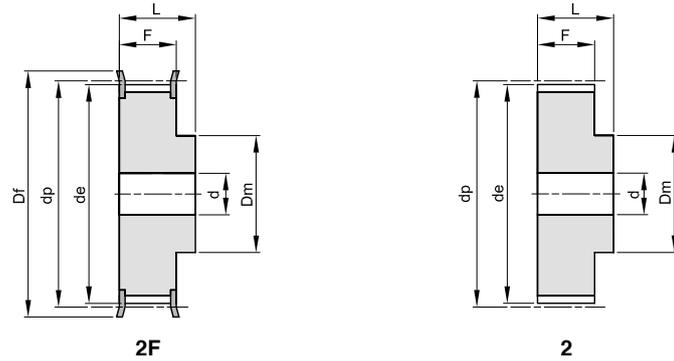

Materiale: Acciaio (St)  
 Materiale: Alluminio UNI 9006 - T6 (Al)  
 adatto per l'ossidazione dura a spessore

descrizione	codice	tipo	materiale	denti	dp	de	Df	Dm	Di	F	L	d	n° flangia	Kg.
12 5M 25	41025012	2F	St	12	19,10	17,96	23	12,5		30,5	36	6	202	0,05
14 5M 25	41025014	2F	St	14	22,28	21,14	25	13,5		30,5	36	6	203	0,08
15 5M 25	41025015	2F	St	15	23,87	22,73	28	16,0		30,5	36	6	204	0,09
16 5M 25	41025016	2F	St	16	25,46	24,32	28	16,5		30,5	36	6	204	0,11
18 5M 25	41025018	2F	St	18	28,65	27,51	32	20,0		30,5	36	6	205	0,13
20 5M 25	41025020	2F	St	20	31,83	30,69	36	23,0		30,5	36	6	206	0,17
21 5M 25	41025021	2F	St	21	33,42	32,28	38	24,0		30,5	38	6	207	0,20
22 5M 25	41025022	2F	St	22	35,01	33,87	38	25,5		30,5	38	6	207	0,22
24 5M 25	41025024	2F	St	24	38,20	37,06	42	27,0		30,5	38	6	208	0,26
26 5M 25	41025026	2F	St	26	41,38	40,24	44	30,0		30,5	38	6	209	0,32
28 5M 25	41025028	2F	St	28	44,56	43,42	48	30,5		30,5	38	6	210	0,37
30 5M 25	41025030	2F	St	30	47,75	46,60	51	35,0		30,5	38	6	211	0,42
32 5M 25	41025032	2F	St	32	50,93	49,79	54	38,0		30,5	38	8	212	0,48
36 5M 25	41025036	2F	St	36	57,30	56,16	60	38,0		30,5	38	8	214	0,59
40 5M 25	41025040	2F	St	40	63,66	62,52	71	38,0		30,5	38	8	217	0,75
44 5M 25	41025044	2	Al	44	70,03	68,89		38,0		30,5	40	8		0,32
48 5M 25	41025048	2	Al	48	76,39	75,25		38,0		30,5	40	8		0,28
60 5M 25	41025060	2	Al	60	95,49	94,35		50,0		30,5	40	8		0,44
72 5M 25	41025072	2	Al	72	114,59	113,45		50,0		30,5	40	8		0,85



# PULEGGE DENTATE PER CINGHIE HTD®

## HTD® TIMING BELT PULLEYS

### 8M

PASSO 8 mm

PER CINGHIE LARGHEZZA 20 mm

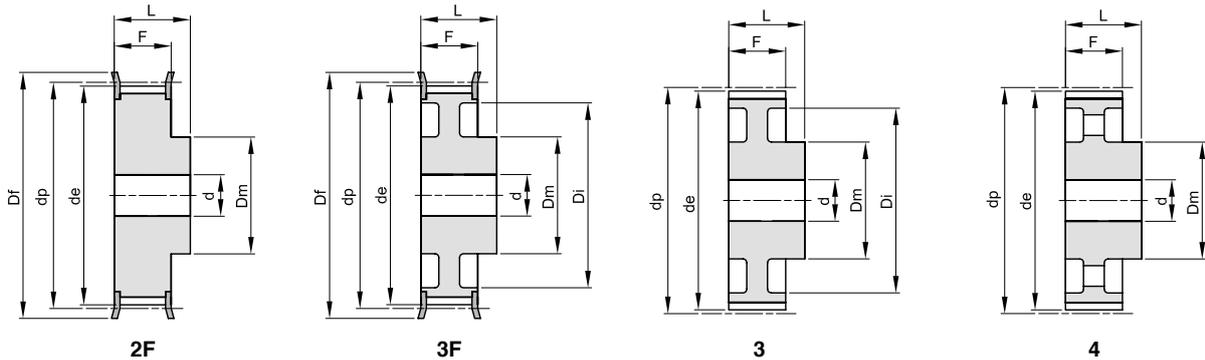

Materiale: Acciaio (St)  
Materiale: Ghisa (GG)

descrizione	codice	tipo	materiale	denti	dp	de	Df	Dm	Di	F	L	d	n° flangia	Kg.
22 8M 20	42020022	2F	St	22	56,02	54,65	60	43		28	38	12	308	0,54
24 8M 20	42020024	2F	St	24	61,11	59,74	66	45		28	38	12	310	0,65
26 8M 20	42020026	2F	St	26	66,21	64,84	71	48		28	38	12	311	0,80
28 8M 20	42020028	2F	St	28	71,30	70,08	75	50		28	38	14	312	0,88
30 8M 20	42020030	2F	St	30	76,39	75,13	83	55		28	38	14	314	1,00
32 8M 20	42020032	2F	St	32	81,49	80,16	87	60		28	38	14	315	1,20
34 8M 20	42020034	2F	St	34	86,58	85,21	91	66		28	38	14	316	1,40
36 8M 20	42020036	2F	St	36	91,67	90,30	98	70		28	38	14	319	1,60
38 8M 20	42020038	2F	St	38	96,77	95,39	103	75		28	38	14	320	1,70
40 8M 20	42020040	2F	St	40	101,86	100,49	106	75		28	38	14	321	1,85
44 8M 20	42020044	2F	St	44	112,05	110,67	119	75		28	38	14	325	2,10
48 8M 20	42020048	2F	St	48	122,23	120,86	127	75		28	38	14	327	2,50
56 8M 20	42020056	3F	St	56	142,60	141,23	148	80	116	28	38	14	333	2,82
64 8M 20	42020064	3F	St	64	162,97	161,60	168	80	137	28	38	14	338	3,22
72 8M 20	42020072	3F	St	72	183,35	181,97	192	80	158	28	38	14	340	3,74
80 8M 20	42020080	3	GG	80	203,72	202,35		90	180	28	38	14		3,78
90 8M 20	42020090	3	GG	90	229,18	227,81		90	204	28	38	14		4,57
* 112 8M 20	42020112	4	GG	112	285,21	283,83		90	254	28	38	18		
* 144 8M 20	42020144	4	GG	144	366,69	365,32		90	336	28	38	20		
* 168 8M 20	42020168	4	GG	168	427,81	426,44		100	400	28	38	20		
* 192 8M 20	42020192	4	GG	192	488,92	487,55		100	460	28	38	20		

\* Costruite a richiesta / Manufactured on request



# PULEGGE DENTATE PER CINGHIE HTD®

## HTD® TIMING BELT PULLEYS

### 8M

PASSO 8 mm

PER CINGHIE LARGHEZZA 30 mm

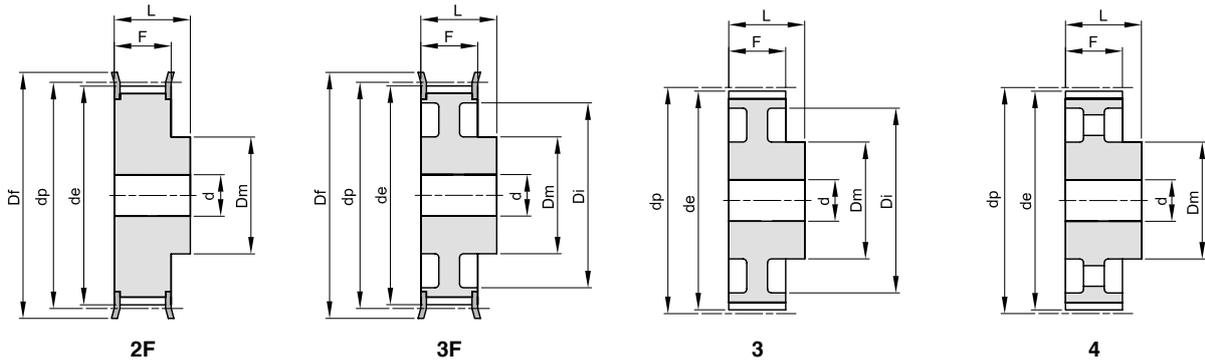

Materiale: Acciaio (St)  
Materiale: Ghisa (GG)

descrizione	codice	tipo	materiale	denti	dp	de	Df	Dm	Di	F	L	d	n° flangia	Kg.
22 8M 30	42030022	2F	St	22	56,02	54,65	60	43		38	48	12	308	0,75
24 8M 30	42030024	2F	St	24	61,11	59,74	66	45		38	48	12	310	0,90
26 8M 30	42030026	2F	St	26	66,21	64,84	71	48		38	48	12	311	1,10
28 8M 30	42030028	2F	St	28	71,30	70,08	75	50		38	48	14	312	1,20
30 8M 30	42030030	2F	St	30	76,39	75,13	83	55		38	48	14	314	1,32
32 8M 30	42030032	2F	St	32	81,49	80,16	87	60		38	48	14	315	1,55
34 8M 30	42030034	2F	St	34	86,58	85,21	91	66		38	48	14	316	1,80
36 8M 30	42030036	2F	St	36	91,67	90,30	98	70		38	48	14	319	2,10
38 8M 30	42030038	2F	St	38	96,77	95,39	103	75		38	48	14	320	2,30
40 8M 30	42030040	2F	St	40	101,86	100,49	106	75		38	48	14	321	2,47
44 8M 30	42030044	2F	St	44	112,05	110,67	119	75		38	48	14	325	2,95
48 8M 30	42030048	2F	St	48	122,23	120,86	127	75		38	48	14	327	3,30
56 8M 30	42030056	3F	St	56	142,60	141,23	148	90	116	38	48	14	333	4,02
64 8M 30	42030064	3F	St	64	162,97	161,60	168	90	137	38	48	14	338	4,60
72 8M 30	42030072	3F	St	72	183,35	181,97	192	95	158	38	48	14	340	5,41
80 8M 30	42030080	3	GG	80	203,72	202,35		100	180	38	48	14		5,23
90 8M 30	42030090	3	GG	90	229,18	227,81		100	204	38	48	14		6,42
112 8M 30	42030112	4	GG	112	285,21	283,83		100	254	38	48	18		8,12
144 8M 30	42030144	4	GG	144	366,69	365,32		100	336	38	48	20		10,36
168 8M 30	42030168	4	GG	168	427,81	426,44		100	400	38	48	20		12,37
192 8M 30	42030192	4	GG	192	488,92	487,55		100	460	38	48	20		14,31



# PULEGGE DENTATE PER CINGHIE HTD®

## HTD® TIMING BELT PULLEYS

### 8M

PASSO 8 mm

PER CINGHIE LARGHEZZA 50 mm

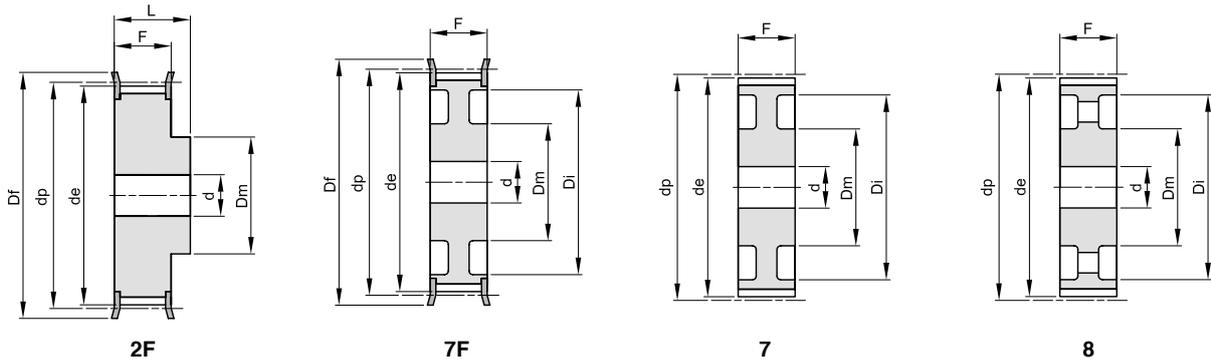

Materiale: Acciaio (St)  
Materiale: Ghisa (GG)

descrizione	codice	tipo	materiale	denti	dp	de	Df	Dm	Di	F	L	d	n° flangia	Kg.
22 8M 50	42050022	2F	St	22	56,02	54,65	60	43		60	70	12	308	1,10
24 8M 50	42050024	2F	St	24	61,11	59,74	66	45		60	70	12	310	1,30
26 8M 50	42050026	2F	St	26	66,21	64,84	71	48		60	70	12	311	1,60
28 8M 50	42050028	2F	St	28	71,30	70,08	75	50		60	70	14	312	1,70
30 8M 50	42050030	2F	St	30	76,39	75,13	83	55		60	70	14	314	2,00
32 8M 50	42050032	2F	St	32	81,49	80,16	87	60		60	70	14	315	2,35
34 8M 50	42050034	2F	St	34	86,58	85,21	91	66		60	70	14	316	2,80
36 8M 50	42050036	2F	St	36	91,67	90,30	98	70		60	70	14	319	3,10
38 8M 50	42050038	2F	St	38	96,77	95,39	103	75		60	70	14	320	3,30
40 8M 50	42050040	2F	St	40	101,86	100,49	106	75		60	70	14	321	3,60
44 8M 50	42050044	2F	St	44	112,05	110,67	119	75		60	70	14	325	4,40
48 8M 50	42050048	2F	St	48	122,23	120,86	127	75		60	70	14	327	5,00
56 8M 50	42050056	7F	St	56	142,60	141,23	148	90	116	60	60	18	333	5,68
64 8M 50	42050064	7F	St	64	162,97	161,60	168	100	137	60	60	18	338	6,93
72 8M 50	42050072	7F	St	72	183,35	181,97	192	100	158	60	60	18	340	7,95
80 8M 50	42050080	7	GG	80	203,72	202,35		110	180	60	60	18		7,96
90 8M 50	42050090	7	GG	90	229,18	227,81		110	204	60	60	18		9,20
112 8M 50	42050112	8	GG	112	285,21	283,83		110	254	60	60	18		12,16
144 8M 50	42050144	8	GG	144	366,69	365,32		110	336	60	60	20		15,68
168 8M 50	42050168	8	GG	168	427,81	426,44		120	400	60	60	20		18,99
192 8M 50	42050192	8	GG	192	488,92	487,55		130	460	60	60	20		24,09



# PULEGGE DENTATE PER CINGHIE HTD®

## HTD® TIMING BELT PULLEYS

### 8M

PASSO 8 mm

PER CINGHIE LARGHEZZA 85 mm

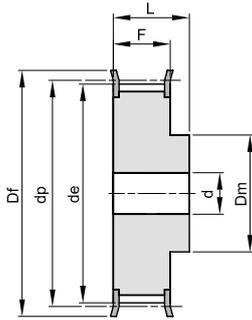

2F

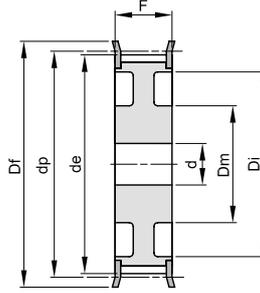

7F

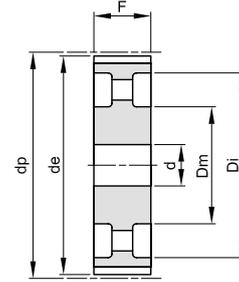

8

Materiale: Acciaio (St)  
Materiale: Ghisa (GG)

descrizione	codice	tipo	materiale	denti	dp	de	Df	Dm	Di	F	L	d	n° flangia	Kg.
22 8M 85	42085022	2F	St	22	56,02	54,65	60	43		95	105	12	308	1,60
24 8M 85	42085024	2F	St	24	61,11	59,74	66	45		95	105	12	310	1,95
26 8M 85	42085026	2F	St	26	66,21	64,84	71	48		95	105	12	311	2,30
28 8M 85	42085028	2F	St	28	71,30	70,08	75	50		95	105	14	312	2,60
30 8M 85	42085030	2F	St	30	76,39	75,13	83	55		95	105	14	314	3,10
32 8M 85	42085032	2F	St	32	81,49	80,16	87	60		95	105	14	315	3,70
34 8M 85	42085034	2F	St	34	86,58	85,21	91	66		95	105	14	316	4,00
36 8M 85	42085036	2F	St	36	91,67	90,30	98	70		95	105	14	319	4,70
38 8M 85	42085038	2F	St	38	96,77	95,39	103	75		95	105	14	320	5,10
40 8M 85	42085040	2F	St	40	101,86	100,49	106	75		95	105	14	321	5,40
44 8M 85	42085044	2F	St	44	112,05	110,67	119	75		95	105	14	325	6,70
48 8M 85	42085048	2F	St	48	122,23	120,86	127	75		95	105	14	327	8,20
56 8M 85	42085056	2F	St	56	142,60	141,23	148	90		95	105	18	333	11,48
64 8M 85	42085064	7F	St	64	162,97	161,60	168	100	137	95	95	18	338	11,02
72 8M 85	42085072	7F	St	72	183,35	181,97	192	100	158	95	95	18	340	13,45
80 8M 85	42085080	8	GG	80	203,72	202,35		110	180	95	95	20		12,36
90 8M 85	42085090	8	GG	90	229,18	227,81		110	204	95	95	20		14,38
112 8M 85	42085112	8	GG	112	285,21	283,83		110	254	95	95	24		18,66
144 8M 85	42085144	8	GG	144	366,69	365,32		110	341	95	95	24		23,00
* 168 8M 85	42085168	8	GG	168	427,81	426,44		120	400	95	95	24		
* 192 8M 85	42085192	8	GG	192	488,92	487,55		130	460	95	95	24		

\* Costruite a richiesta / Manufactured on request



# PULEGGE DENTATE PER CINGHIE HTD®

## HTD® TIMING BELT PULLEYS

### 14M

#### PASSO 14 mm

PER CINGHIE LARGHEZZA 40 mm

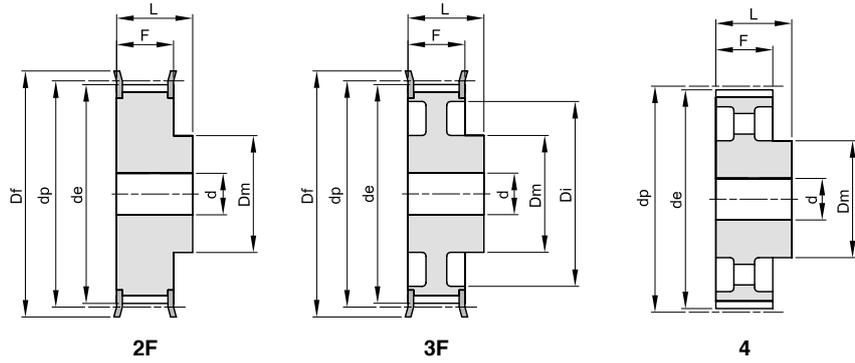

Materiale: Acciaio (St)  
Materiale: Ghisa (GG)

descrizione	codice	tipo	materiale	denti	dp	de	Df	Dm	Di	F	L	d	n° flangia	Kg.
28 14M 40	43040028	2F	St	28	124,78	122,12	127	100		54	69	24	400	4,80
30 14M 40	43040030	2F	St	30	133,69	130,99	138	100		54	69	24	401	5,60
32 14M 40	43040032	2F	St	32	142,60	139,88	154	100		54	69	24	403	6,20
34 14M 40	43040034	2F	St	34	151,52	148,79	160	100		54	69	24	404	6,90
36 14M 40	43040036	2F	St	36	160,43	157,68	168	100		54	69	24	405	7,70
38 14M 40	43040038	2F	St	38	169,34	166,60	183	120		54	69	24	406	8,90
40 14M 40	43040040	2F	St	40	178,25	175,49	188	120		54	69	24	407	9,80
44 14M 40	43040044	2F	St	44	196,08	193,28	211	120		54	69	24	411	12,00
48 14M 40	43040048	3F	GG	48	213,90	211,11	226	135	170	54	69	24	412	11,98
56 14M 40	43040056	3F	GG	56	249,55	246,76	256	135	207	54	69	28	416	14,01
64 14M 40	43040064	3F	GG	64	285,21	282,41	296	135	240	54	69	28	418	16,65
72 14M 40	43040072	4	GG	72	320,86	318,06		135	278	54	69	28		15,52
80 14M 40	43040080	4	GG	80	356,51	353,71		135	314	54	69	28		17,23
90 14M 40	43040090	4	GG	90	401,07	398,28		135	358	54	69	28		19,40
112 14M 40	43040112	4	GG	112	499,11	496,32		135	456	54	69	28		24,14
* 144 14M 40	43040144	4	GG	144	641,71	638,92		135	600	54	69	28		
* 168 14M 40	43040168	4	GG	168	748,66	745,87		135	706	54	69	28		
* 192 14M 40	43040192	4	GG	192	855,62	852,82		135	813	54	69	28		

\* Costruite a richiesta / Manufactured on request



# PULEGGE DENTATE PER CINGHIE HTD®

## HTD® TIMING BELT PULLEYS

### 14M

#### PASSO 14 mm

PER CINGHIE LARGHEZZA 55 mm

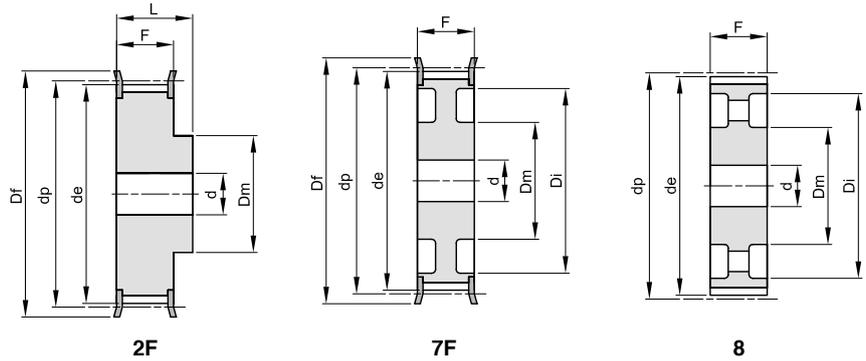

Materiale: Acciaio (St)  
Materiale: Ghisa (GG)

descrizione	codice	tipo	materiale	denti	dp	de	Df	Dm	Di	F	L	d	n° flangia	Kg.
28 14M 55	43055028	2F	St	28	124,78	122,12	127	100		70	85	24	400	5,70
30 14M 55	43055030	2F	St	30	133,69	130,99	138	100		70	85	24	401	7,10
32 14M 55	43055032	2F	St	32	142,60	139,88	154	100		70	85	24	403	7,90
34 14M 55	43055034	2F	St	34	151,52	148,79	160	100		70	85	24	404	9,33
36 14M 55	43055036	2F	St	36	160,43	157,68	168	100		70	85	24	405	10,49
38 14M 55	43055038	2F	St	38	169,34	166,60	183	120		70	85	24	406	12,11
40 14M 55	43055040	2F	St	40	178,25	175,49	188	120		70	85	24	407	13,30
44 14M 55	43055044	2F	St	44	196,08	193,28	211	120		70	85	24	411	16,12
48 14M 55	43055048	7F	GG	48	213,90	211,11	226	135	170	70	70	24	412	13,50
56 14M 55	43055056	7F	GG	56	249,55	246,76	256	135	207	70	70	28	416	15,78
64 14M 55	43055064	7F	GG	64	285,21	282,41	296	135	240	70	70	28	418	19,04
72 14M 55	43055072	8	GG	72	320,86	318,06		135	278	70	70	28		18,41
80 14M 55	43055080	8	GG	80	356,51	353,71		135	314	70	70	28		20,27
90 14M 55	43055090	8	GG	90	401,07	398,28		135	358	70	70	28		22,98
112 14M 55	43055112	8	GG	112	499,11	496,32		135	456	70	70	28		29,29
144 14M 55	43055144	8	GG	144	641,71	638,92		135	600	70	70	28		36,00
168 14M 55	43055168	8	GG	168	748,66	745,87		135	706	70	70	28		40,00
192 14M 55	43055192	8	GG	192	855,62	852,82		135	813	70	70	28		67,00



# PULEGGE DENTATE PER CINGHIE HTD®

## HTD® TIMING BELT PULLEYS

### 14M

#### PASSO 14 mm

PER CINGHIE LARGHEZZA 85 mm

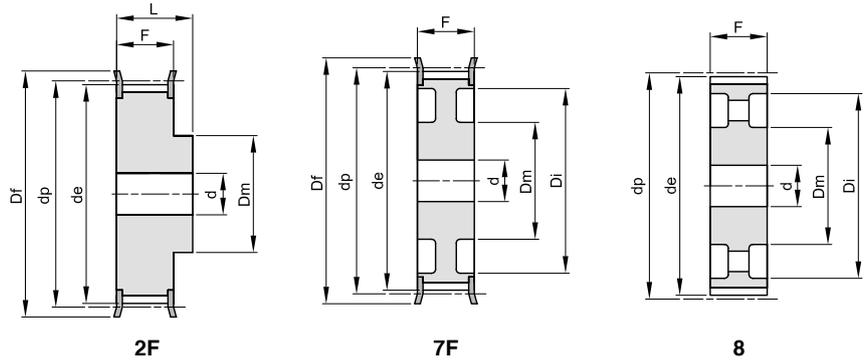

Materiale: Acciaio (St)  
Materiale: Ghisa (GG)

descrizione	codice	tipo	materiale	denti	dp	de	Df	Dm	Di	F	L	d	n° flangia	Kg.
28 14M 85	43085028	2F	St	28	124,78	122,12	127	100		102	117	24	400	8,77
30 14M 85	43085030	2F	St	30	133,69	130,99	138	100		102	117	24	401	10,13
32 14M 85	43085032	2F	St	32	142,60	139,88	154	100		102	117	24	403	11,65
34 14M 85	43085034	2F	St	34	151,52	148,79	160	100		102	117	24	404	13,15
36 14M 85	43085036	2F	St	36	160,43	157,68	168	100		102	117	32	405	14,48
38 14M 85	43085038	2F	St	38	169,34	166,60	183	120		102	117	32	406	16,62
40 14M 85	43085040	2F	St	40	178,25	175,49	188	135		102	117	32	407	18,84
44 14M 85	43085044	2F	St	44	196,08	193,28	211	135		102	117	32	411	22,86
48 14M 85	43085048	2F	St	48	213,90	211,11	226	150		102	117	32	412	27,00
56 14M 85	43085056	7F	GG	56	249,55	246,76	256	150	207	102	102	32	416	24,19
64 14M 85	43085064	7F	GG	64	285,21	282,41	296	150	240	102	102	32	418	28,57
72 14M 85	43085072	8	GG	72	320,86	318,06		150	278	102	102	32		28,26
80 14M 85	43085080	8	GG	80	356,51	353,71		150	314	102	102	32		31,00
90 14M 85	43085090	8	GG	90	401,07	398,28		150	358	102	102	32		35,00
112 14M 85	43085112	8	GG	112	499,11	496,32		150	456	102	102	32		43,50
144 14M 85	43085144	8	GG	144	641,71	638,92		150	600	102	102	32		60,00
168 14M 85	43085168	8	GG	168	748,66	745,87		150	706	102	102	32		63,00
192 14M 85	43085192	8	GG	192	855,62	852,82		165	813	102	102	32		76,00



# PULEGGE DENTATE PER CINGHIE HTD®

## HTD® TIMING BELT PULLEYS

### 14M

#### PASSO 14 mm

PER CINGHIE LARGHEZZA 115 mm

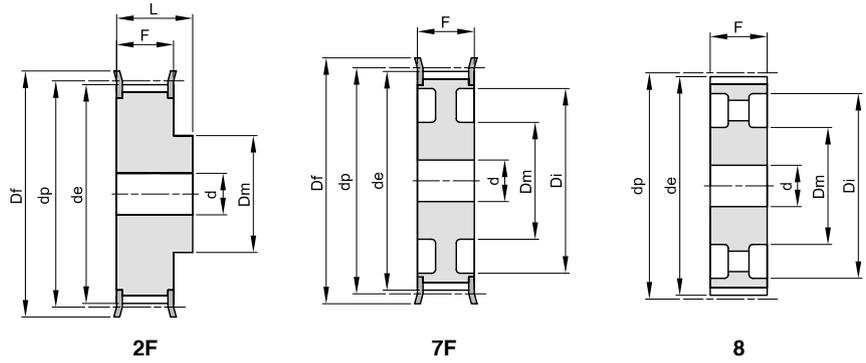

Materiale: Acciaio (St)  
Materiale: Ghisa (GG)

descrizione	codice	tipo	materiale	denti	dp	de	Df	Dm	Di	F	L	d	n° flangia	Kg.
28 14M 115	43115028	2F	St	28	124,78	122,12	127	100		133	148	32	400	10,75
30 14M 115	43115030	2F	St	30	133,69	130,99	138	100		133	148	32	401	12,52
32 14M 115	43115032	2F	St	32	142,60	139,88	154	100		133	148	32	403	14,48
34 14M 115	43115034	2F	St	34	151,52	148,79	160	100		133	148	32	404	16,45
36 14M 115	43115036	2F	St	36	160,43	157,68	168	120		133	148	32	405	18,99
38 14M 115	43115038	2F	St	38	169,34	166,60	183	120		133	148	32	406	21,31
40 14M 115	43115040	2F	St	40	178,25	175,49	188	135		133	148	32	407	24,04
44 14M 115	43115044	2F	St	44	196,08	193,28	211	140		133	148	32	411	29,41
48 14M 115	43115048	2F	St	48	213,90	211,11	226	150		133	148	32	412	35,00
56 14M 115	43115056	2F	St	56	249,55	246,76	256	150		133	148	32	416	48,00
64 14M 115	43115064	7F	GG	64	285,21	282,41	296	150	240	133	133	32	418	36,00
72 14M 115	43115072	8	GG	72	320,86	318,06		150	278	133	133	32		36,00
80 14M 115	43115080	8	GG	80	356,51	353,71		150	314	133	133	32		40,00
90 14M 115	43115090	8	GG	90	401,07	398,28		150	358	133	133	32		45,00
112 14M 115	43115112	8	GG	112	499,11	496,32		150	456	133	133	32		55,50
144 14M 115	43115144	8	GG	144	641,71	638,92		165	600	133	133	32		71,00
168 14M 115	43115168	8	GG	168	748,66	745,87		165	706	133	133	32		83,00
192 14M 115	43115192	8	GG	192	855,62	852,82		165	813	133	133	32		96,00



# PULEGGE DENTATE PER CINGHIE HTD®

## HTD® TIMING BELT PULLEYS

### 14M

#### PASSO 14 mm

PER CINGHIE LARGHEZZA 170 mm

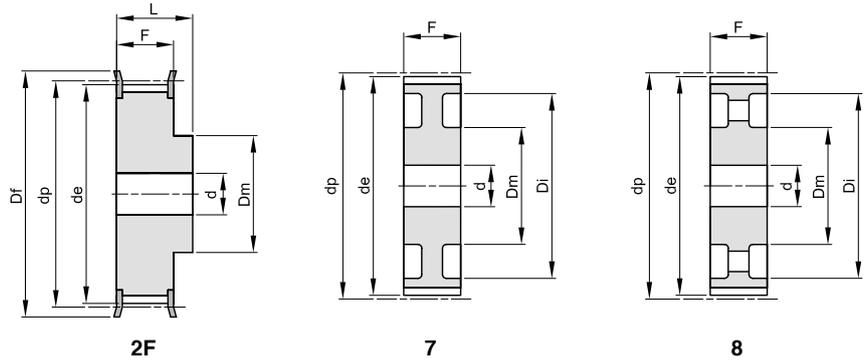

Materiale: Acciaio (St)  
Materiale: Ghisa (GG)

descrizione	codice	tipo	materiale	denti	dp	de	Df	Dm	Di	F	L	d	n° flangia	Kg.
28 14M 170	43170028	2F	St	28	124,78	122,12	127	100		187	202	32	400	14,79
30 14M 170	43170030	2F	St	30	133,69	130,99	138	100		187	202	32	401	17,24
32 14M 170	43170032	2F	St	32	142,60	139,88	154	100		187	202	32	403	19,92
34 14M 170	43170034	2F	St	34	151,52	148,79	160	100		187	202	32	404	22,72
36 14M 170	43170036	2F	St	36	160,43	157,68	168	120		187	202	32	405	26,07
38 14M 170	43170038	2F	St	38	169,34	166,60	183	135		187	202	32	406	29,71
40 14M 170	43170040	2F	St	40	178,25	175,49	188	140		187	202	32	407	33,00
* 44 14M 170	43170044	2F	St	44	196,08	193,28	211	160		187	202	32	411	
* 48 14M 170	43170048	2F	St	48	213,90	211,11	226	160		187	202	32	412	
* 56 14M 170	43170056	2F	St	56	249,55	246,76	256	160		187	202	32	416	
* 64 14M 170	43170064	2F	St	64	285,21	282,41	296	180		187	202	32	418	
* 72 14M 170	43170072	7	GG	72	320,86	318,06		180	278	187	187	32		
80 14M 170	43170080	7	GG	80	356,51	353,71		180	314	187	187	32		71,00
90 14M 170	43170090	8	GG	90	401,07	398,28		180	358	187	187	38		73,00
112 14M 170	43170112	8	GG	112	499,11	496,32		200	456	187	187	38		95,00
144 14M 170	43170144	8	GG	144	641,71	638,92		220	600	187	187	38		114,00
168 14M 170	43170168	8	GG	168	748,66	745,87		220	706	187	187	38		142,00
* 192 14M 170	43170192	8	GG	192	855,62	852,82		220	813	187	187	38		

\* Costruite a richiesta / Manufactured on request



# PULEGGE DENTATE A BUSSOLA CONICA PER CINGHIE HTD®

## HTD® TIMING BELT PULLEYS FOR TAPER BUSHES

### 5M

PASSO 5 mm

PER CINGHIE LARGHEZZA 15 mm

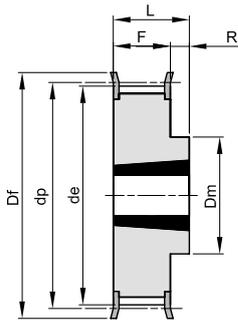

10F

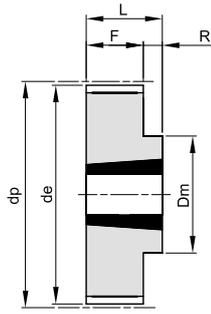

10

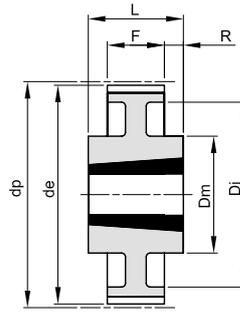

13

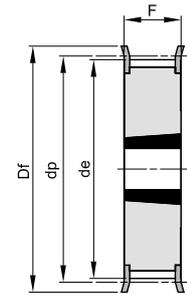

15F

Materiale: Acciaio (St)

descrizione	codice	tipo	materiale	denti	bussola	foro max	dp	de	Df	Dm	Di	F	L	R	n° flangia	Kg.
TL 34 5M 15	46015034	15F	St	34	1008	25	54,11	52,97	57			22	22		213	0,20
TL 36 5M 15	46015036	15F	St	36	1108	28	57,30	56,15	60			22	22		214	0,25
TL 38 5M 15	46015038	15F	St	38	1108	28	60,48	59,34	66			22	22		216	0,30
TL 40 5M 15	46015040	15F	St	40	1108	28	63,66	62,52	71			22	22		217	0,35
TL 44 5M 15	46015044	15F	St	44	1108	28	70,03	68,89	75			22	22		218	0,40
TL 48 5M 15	46015048	10F	St	48	1210	32	76,39	75,25	83	59		22	25	3	219	0,46
TL 56 5M 15	46015056	10F	St	56	1210	32	89,13	87,99	93	70		22	25	3	222	0,60
TL 64 5M 15	46015064	10F	St	64	1210	32	101,86	100,72	106	80		22	25	3	224	0,80
TL 72 5M 15	46015072	10	St	72	1610	42	114,59	113,45		92		22	25	3		1,20
TL 80 5M 15	46015080	10	St	80	1610	42	127,32	126,18		92		22	25	3		1,76
TL 90 5M 15	46015090	10	St	90	1610	42	143,24	142,10		92		22	25	3		2,32
TL112 5M 15	46015112	10	St	112	2012	50	178,25	177,11		110		20	32	12		3,72
TL136 5M 15	46015136	13	St	136	2012	50	216,45	215,31		110	199	20	32	6		3,82



# PULEGGE DENTATE A BUSSOLA CONICA PER CINGHIE HTD®

## HTD® TIMING BELT PULLEYS FOR TAPER BUSHES

### 8M

PASSO 8 mm

PER CINGHIE LARGHEZZA 20 mm

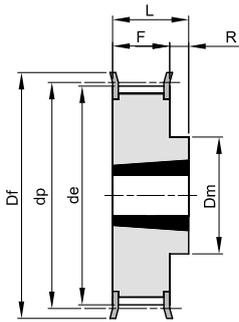

10F

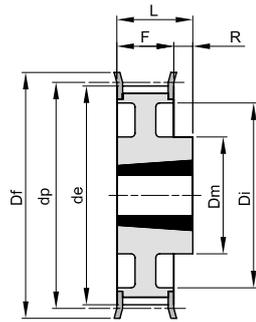

11F

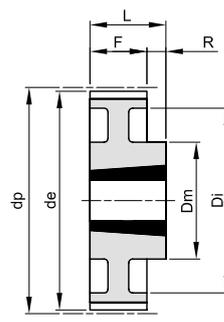

11

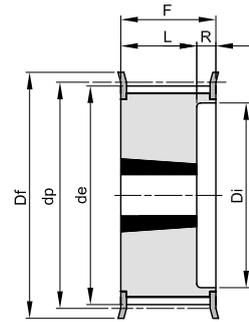

16F

Materiale: Acciaio (St)  
Materiale: Ghisa (GG)

descrizione	codice	tipo	materiale	denti	bussola	foro max	dp	de	Df	Dm	Di	F	L	R	n° flangia	Kg.
TL 22 8M 20	47020022	16F	St	22	1008	25	56,02	54,65	60		37	28	22	6	308	0,25
TL 24 8M 20	47020024	16F	St	24	1108	28	61,11	59,74	66		44	28	22	6	310	0,30
TL 26 8M 20	47020026	16F	St	26	1108	28	66,21	64,84	71		45	28	22	6	311	0,36
TL 28 8M 20	47020028	16F	St	28	1108	28	71,30	70,08	75		50	28	22	6	312	0,45
TL 30 8M 20	47020030	16F	St	30	1108	28	76,39	75,13	83		58	28	22	6	314	0,55
TL 32 8M 20	47020032	16F	St	32	1610	42	81,49	80,16	87		63	28	25	3	315	0,43
TL 34 8M 20	47020034	16F	St	34	1610	42	86,58	85,21	91		64	28	25	3	316	0,57
TL 36 8M 20	47020036	16F	St	36	1610	42	91,67	90,30	98		68	28	25	3	319	0,70
TL 38 8M 20	47020038	16F	St	38	1610	42	96,77	95,39	103		72	28	25	3	320	0,82
TL 40 8M 20	47020040	16F	St	40	1610	42	101,86	100,49	106		76	28	25	3	321	1,10
TL 44 8M 20	47020044	10F	St	44	2012	50	112,05	110,67	119	92		28	32	4	325	1,20
TL 48 8M 20	47020048	10F	St	48	2012	50	122,23	120,86	127	96		28	32	4	327	1,65
TL 56 8M 20	47020056	10F	St	56	2012	50	142,60	141,23	148	110		28	32	4	333	2,50
TL 64 8M 20	47020064	11F	St	64	2012	50	162,97	161,60	168	110	137	28	32	4	338	2,60
TL 72 8M 20	47020072	11F	St	72	2012	50	183,35	181,97	192	110	158	28	32	4	340	3,40
TL 80 8M 20	47020080	11	GG	80	2012	50	203,72	202,35		110	180	28	32	4		3,60
TL 90 8M 20	47020090	11	GG	90	2012	50	229,18	227,81		110	204	28	32	4		4,10



# PULEGGE DENTATE A BUSSOLA CONICA PER CINGHIE HTD®

## HTD® TIMING BELT PULLEYS FOR TAPER BUSHES

### 8M

#### PASSO 8 mm

PER CINGHIE LARGHEZZA 30 mm

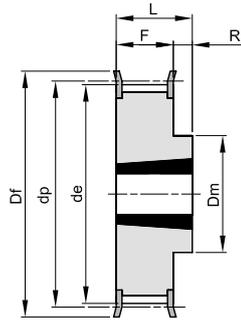

10F

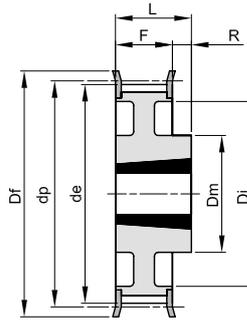

11F

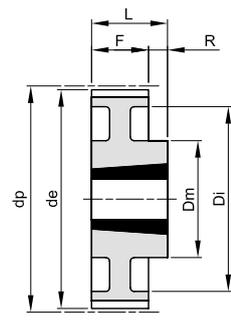

11

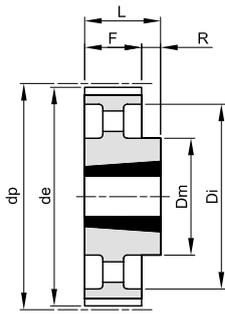

12

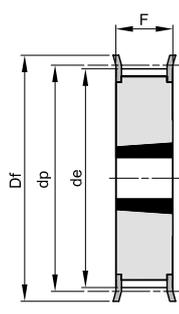

15F

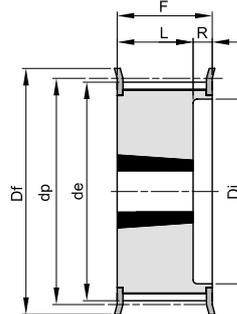

16F

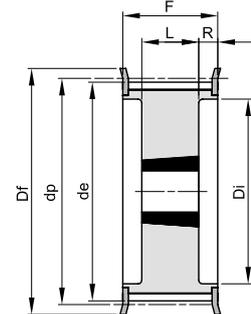

18F

Materiale: Acciaio (St)  
Materiale: Ghisa (GG)

descrizione	codice	tipo	materiale	denti	bussola	foro max	dp	de	Df	Dm	Di	F	L	R	n° flangia	Kg.
TL 22 8M 30	47030022	16F	St	22	1008	25	56,02	54,65	60		37	38	22	16	308	0,33
TL 24 8M 30	47030024	16F	St	24	1108	28	61,11	59,74	66		44	38	22	16	310	0,40
TL 26 8M 30	47030026	16F	St	26	1108	28	66,21	64,84	71		44	38	22	16	311	0,45
TL 28 8M 30	47030028	16F	St	28	1210	32	71,30	70,08	75		50	38	25	13	312	0,50
TL 30 8M 30	47030030	15F	St	30	1615	42	76,39	75,13	83			38	38		314	0,55
TL 32 8M 30	47030032	15F	St	32	1615	42	81,49	80,16	87			38	38		315	0,60
TL 34 8M 30	47030034	15F	St	34	1615	42	86,58	85,21	91			38	38		316	0,80
TL 36 8M 30	47030036	15F	St	36	1615	42	91,67	90,30	98			38	38		319	1,00
TL 38 8M 30	47030038	15F	St	38	1615	42	96,77	95,39	103			38	38		320	1,10
TL 40 8M 30	47030040	15F	St	40	1615	42	101,86	100,49	106			38	38		321	1,34
TL 44 8M 30	47030044	18F	St	44	2012	50	112,05	110,67	119		86	38	32	3	325	1,30
TL 48 8M 30	47030048	18F	St	48	2012	50	122,23	120,86	127		90	38	32	3	327	1,80
TL 56 8M 30	47030056	18F	St	56	2012	50	142,60	141,23	148		110	38	32	3	333	3,80
TL 64 8M 30	47030064	10F	St	64	2517	60	162,97	161,60	168	125		38	45	7	338	4,30
TL 72 8M 30	47030072	11F	St	72	2517	60	183,35	181,97	192	125	158	38	45	7	340	4,40
TL 80 8M 30	47030080	11	GG	80	2517	60	203,72	202,35		125	180	38	45	7		4,65
TL 90 8M 30	47030090	11	GG	90	2517	60	229,18	227,81		125	204	38	45	7		5,80
TL112 8M 30	47030112	12	GG	112	2517	60	285,21	283,83		125	254	38	45	7		6,20
TL144 8M 30	47030144	12	GG	144	2517	60	366,69	365,32		125	336	38	45	7		9,00



# PULEGGE DENTATE A BUSSOLA CONICA PER CINGHIE HTD®

## HTD® TIMING BELT PULLEYS FOR TAPER BUSHES

### 8M

#### PASSO 8 mm

PER CINGHIE LARGHEZZA 50 mm

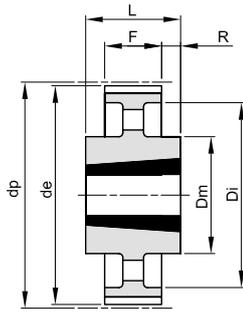

14

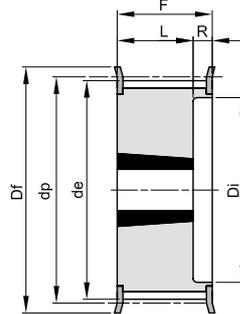

16F

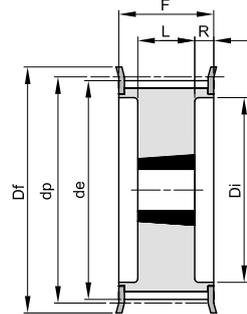

18F

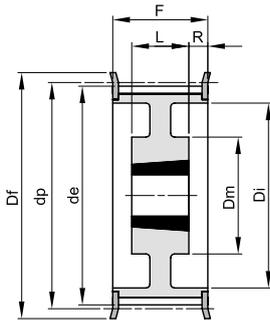

19F

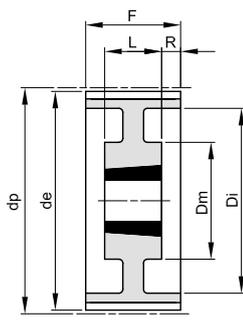

19

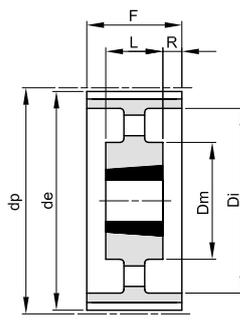

20

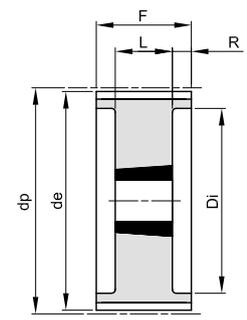

18

Materiale: Acciaio (St)  
Materiale: Ghisa (GG)

descrizione	codice	tipo	materiale	denti	bussola	foro max	dp	de	Df	Dm	Di	F	L	R	n° flangia	Kg.
TL 28 8M 50	47050028	16F	St	28	1210	32	71,30	70,08	75		50	60	25	35	312	0,60
TL 30 8M 50	47050030	16F	St	30	1615	42	76,39	75,13	83		58	60	38	22	314	0,65
TL 32 8M 50	47050032	16F	St	32	1615	42	81,49	80,16	87		63	60	38	22	315	0,80
TL 34 8M 50	47050034	16F	St	34	1615	42	86,58	85,21	91		65	60	38	22	316	1,08
TL 36 8M 50	47050036	16F	St	36	1615	42	91,67	90,30	98		68	60	38	22	319	1,35
TL 38 8M 50	47050038	16F	St	38	1615	42	96,77	95,39	103		72	60	38	22	320	1,65
TL 40 8M 50	47050040	18F	St	40	2012	50	101,86	100,49	106		80	60	32	14	321	1,70
TL 44 8M 50	47050044	18F	St	44	2012	50	112,05	110,67	119		86	60	32	14	325	1,80
TL 48 8M 50	47050048	18F	St	48	2012	50	122,23	120,86	127		95	60	32	14	327	2,35
TL 56 8M 50	47050056	18F	St	56	2517	60	142,60	141,23	148		116	60	45	7,5	333	3,35
TL 64 8M 50	47050064	18F	St	64	2517	60	162,97	161,60	168		136	60	45	7,5	338	4,90
TL 72 8M 50	47050072	19F	St	72	2517	60	183,35	181,97	192	125	158	60	45	7,5	340	6,90
TL 80 8M 50	47050080	18	GG	80	3020	75	203,72	202,35			180	60	51	4,5		8,90
TL 90 8M 50	47050090	19	GG	90	3020	75	229,18	227,81		160	204	60	51	4,5		9,90
TL112 8M 50	47050112	19	GG	112	3020	75	285,21	283,83		170	254	60	51	4,5		12,10
TL144 8M 50	47050144	20	GG	144	3020	75	366,69	365,32		170	336	60	51	4,5		15,40
TL168 8M 50	47050168	14	GG	168	3525	90	427,81	426,44		198	395	60	65	2,5		22,80
TL192 8M 50	47050192	14	GG	192	3525	90	488,92	487,55		198	455	60	65	2,5		26,50



# PULEGGE DENTATE A BUSSOLA CONICA PER CINGHIE HTD®

## HTD® TIMING BELT PULLEYS FOR TAPER BUSHES

### 8M

PASSO 8 mm

PER CINGHIE LARGHEZZA 85 mm

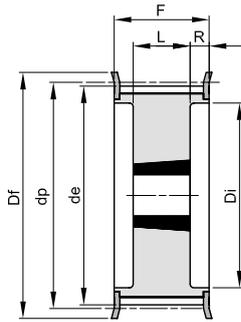

18F

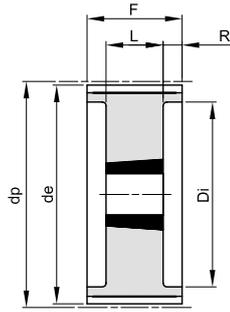

18

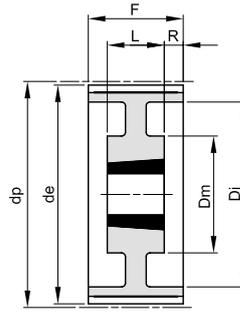

19

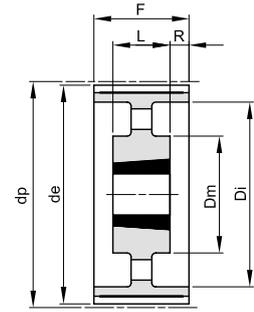

20

Materiale: Acciaio (St)  
Materiale: Ghisa (GG)

descrizione	codice	tipo	materiale	denti	bussola	foro max	dp	de	Df	Dm	Di	F	L	R	n° flangia	Kg.
TL 34 8M 85	47085034	18F	St	34	1615	42	86,58	85,22	91		65	95	38	28,5	316	1,50
TL 36 8M 85	47085036	18F	St	36	1615	42	91,67	90,30	98		68	95	38	28,5	319	1,90
TL 38 8M 85	47085038	18F	St	38	1615	42	96,77	95,39	103		72	95	38	28,5	320	2,20
TL 40 8M 85	47085040	18F	St	40	2012	50	101,86	100,49	106		80	95	32	31,5	321	1,90
TL 44 8M 85	47085044	18F	St	44	2012	50	112,05	110,67	119		86	95	32	31,5	325	2,30
TL 48 8M 85	47085048	18F	St	48	2517	60	122,23	120,86	127		97	95	45	25	327	2,70
TL 56 8M 85	47085056	18F	St	56	2517	60	142,60	141,23	148		116	95	45	25	333	4,50
TL 64 8M 85	47085064	18F	St	64	2517	60	162,97	161,60	168		136	95	45	25	338	6,30
TL 72 8M 85	47085072	18F	St	72	3020	75	183,35	181,97	192		150	95	51	22	340	8,10
TL 80 8M 85	47085080	18	GG	80	3020	75	203,72	202,35			180	95	51	22		10,20
TL 90 8M 85	47085090	19	GG	90	3020	75	229,18	227,81		170	204	95	51	22		11,20
TL112 8M 85	47085112	19	GG	112	3020	75	285,21	283,83		170	254	95	51	22		15,00
TL144 8M 85	47085144	20	GG	144	3525	90	366,69	365,32		198	336	95	65	15		20,20
TL168 8M 85	47085168	20	GG	168	3525	90	427,81	426,44		198	395	95	65	15		22,40
TL192 8M 85	47085192	20	GG	192	3525	90	488,92	487,55		198	455	95	65	15		28,20



# PULEGGE DENTATE A BUSSOLA CONICA PER CINGHIE HTD®

## HTD® TIMING BELT PULLEYS FOR TAPER BUSHES

### 14M

PASSO 14 mm

PER CINGHIE LARGHEZZA 40 mm

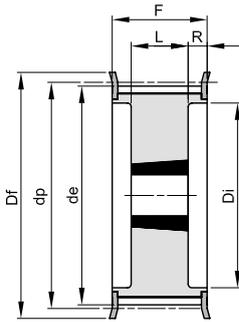

18F

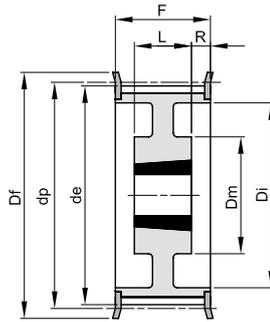

19F

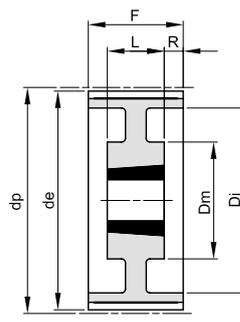

19

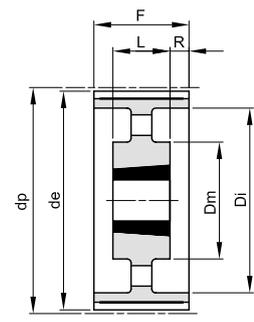

20

Materiale: Acciaio (St)  
Materiale: Ghisa (GG)

descrizione	codice	tipo	materiale	denti	bussola	foro max	dp	de	Df	Dm	Di	F	L	R	n° flangia	Kg.
TL 28 14M 40	48040028	18F	St	28	2012	50	124,78	122,12	127		94	54	32	11	400	2,10
TL 30 14M 40	48040030	18F	St	30	2012	50	133,69	130,99	138		98	54	32	11	401	2,70
TL 32 14M 40	48040032	18F	St	32	2012	50	142,60	139,88	154		108	54	32	11	403	3,40
TL 34 14M 40	48040034	18F	St	34	2517	60	151,52	148,79	160		110	54	45	4,5	404	3,90
TL 36 14M 40	48040036	18F	St	36	2517	60	160,43	157,68	168		120	54	45	4,5	405	4,80
TL 38 14M 40	48040038	18F	St	38	2517	60	169,34	166,60	183		130	54	45	4,5	406	5,40
TL 40 14M 40	48040040	18F	St	40	2517	60	178,25	175,49	188		138	54	45	4,5	407	6,00
TL 44 14M 40	48040044	18F	St	44	3020	75	196,08	193,28	211		155	54	51	1,5	411	7,70
TL 48 14M 40	48040048	18F	St	48	3020	75	213,90	211,11	226		170	54	51	1,5	412	9,90
TL 56 14M 40	48040056	18F	GG	56	3020	75	249,55	246,76	256		208	54	51	1,5	416	10,70
TL 64 14M 40	48040064	19F	GG	64	3020	75	285,21	282,41	296	170	240	54	51	1,5	418	13,30
TL 72 14M 40	48040072	19	GG	72	3020	75	320,86	318,06		170	280	54	51	1,5		15,00
TL 80 14M 40	48040080	20	GG	80	3020	75	356,51	353,71		170	315	54	51	1,5		16,00
TL 90 14M 40	48040090	20	GG	90	3020	75	401,07	398,28		170	360	54	51	1,5		18,00
TL112 14M 40	48040112	20	GG	112	3020	75	499,11	496,32		170	457	54	51	1,5		25,50
TL144 14M 40	48040144	20	GG	144	3020	75	641,71	638,92		170	600	54	51	1,5		32,00
TL168 14M 40	48040168	20	GG	168	3020	75	748,66	745,87		170	706	54	51	1,5		43,50
TL192 14M 40	48040192	20	GG	192	3020	75	855,62	852,82		170	813	54	51	1,5		49,50



# PULEGGE DENTATE A BUSSOLA CONICA PER CINGHIE HTD®

## HTD® TIMING BELT PULLEYS FOR TAPER BUSHES

# 14M

## PASSO 14 mm

PER CINGHIE LARGHEZZA 55 mm

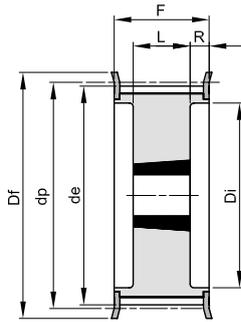

18F

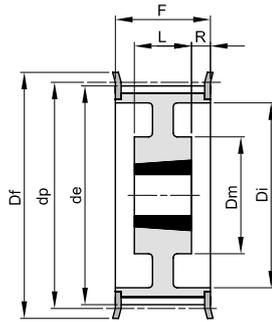

19F

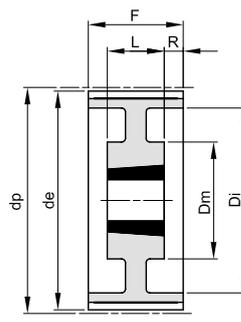

19

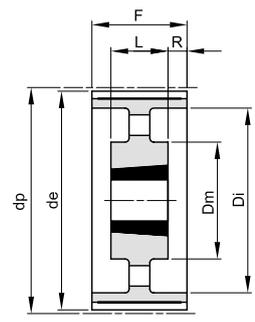

20

Materiale: Acciaio (St)  
Materiale: Ghisa (GG)

descrizione	codice	tipo	materiale	denti	bussola	foro max	dp	de	Df	Dm	Di	F	L	R	n° flangia	Kg.
TL 28 14M 55	48055028	18F	St	28	2012	50	124,78	122,12	127		94	70	32	19	400	2,20
TL 30 14M 55	48055030	18F	St	30	2517	60	133,69	130,99	138		100	70	45	12,5	401	2,70
TL 32 14M 55	48055032	18F	St	32	2517	60	142,60	139,88	154		108	70	45	12,5	403	3,60
TL 34 14M 55	48055034	18F	St	34	2517	60	151,52	148,79	160		110	70	45	12,5	404	4,50
TL 36 14M 55	48055036	18F	St	36	2517	60	160,43	157,68	168		120	70	45	12,5	405	5,20
TL 38 14M 55	48055038	18F	St	38	2517	60	169,34	166,60	183		130	70	45	12,5	406	6,20
TL 40 14M 55	48055040	18F	St	40	2517	60	178,25	175,49	188		138	70	45	12,5	407	6,90
TL 44 14M 55	48055044	18F	St	44	3020	75	196,08	193,28	211		155	70	51	9,5	411	8,60
TL 48 14M 55	48055048	18F	St	48	3020	75	213,90	211,11	226		170	70	51	9,5	412	10,50
TL 56 14M 55	48055056	18F	GG	56	3020	75	249,55	246,76	256		208	70	51	9,5	416	12,50
TL 64 14M 55	48055064	19F	GG	64	3020	75	285,21	282,41	296	170	240	70	51	9,5	418	15,60
TL 72 14M 55	48055072	19	GG	72	3020	75	320,86	318,06		170	280	70	51	9,5		17,45
TL 80 14M 55	48055080	20	GG	80	3020	75	356,51	353,71		170	315	70	51	9,5		17,45
TL 90 14M 55	48055090	20	GG	90	3020	75	401,07	398,28		170	360	70	51	9,5		19,90
TL112 14M 55	48055112	20	GG	112	3020	75	499,11	496,32		170	457	70	51	9,5		27,50
TL144 14M 55	48055144	20	GG	144	3020	75	641,71	638,92		170	600	70	51	9,5		37,00
TL168 14M 55	48055168	20	GG	168	3020	75	748,66	745,87		170	706	70	51	9,5		50,00
TL192 14M 55	48055192	20	GG	192	3020	75	855,62	852,82		170	813	70	51	9,5		62,00



# PULEGGE DENTATE A BUSSOLA CONICA PER CINGHIE HTD®

## HTD® TIMING BELT PULLEYS FOR TAPER BUSHES

# 14M

## PASSO 14 mm

PER CINGHIE LARGHEZZA 85 mm

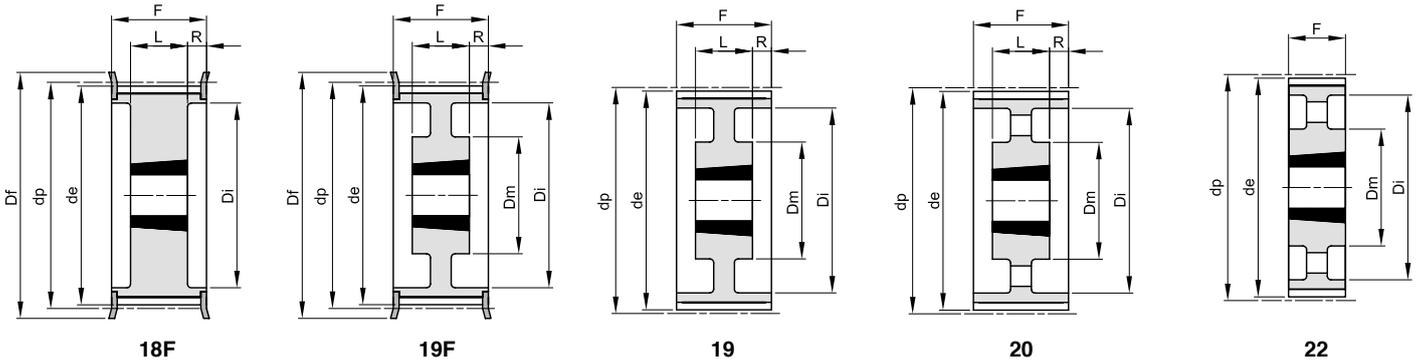

Materiale: Acciaio (St)  
Materiale: Ghisa (GG)

descrizione	codice	tipo	materiale	denti	bussola	foro max	dp	de	Df	Dm	Di	F	L	R	n° flangia	Kg.
TL 28 14M 85	48085028	18F	St	28	2517	60	124,78	122,12	127		98	102	45	28,5	400	2,70
TL 30 14M 85	48085030	18F	St	30	2517	60	133,69	130,99	138		100	102	45	28,5	401	3,80
TL 32 14M 85	48085032	18F	St	32	2517	60	142,60	139,88	154		108	102	45	28,5	403	4,70
TL 34 14M 85	48085034	18F	St	34	2517	60	151,52	148,79	160		110	102	45	28,5	404	6,00
TL 36 14M 85	48085036	18F	St	36	3020	75	160,43	157,68	168		125	102	51	25,5	405	5,70
TL 38 14M 85	48085038	18F	St	38	3020	75	169,34	166,60	183		130	102	51	25,5	406	6,80
TL 40 14M 85	48085040	18F	St	40	3020	75	178,25	175,49	188		138	102	51	25,5	407	8,00
TL 44 14M 85	48085044	18F	St	44	3030	75	196,08	193,28	211		155	102	76	13	411	11,70
TL 48 14M 85	48085048	18F	St	48	3030	75	213,90	211,11	226		170	102	76	13	412	15,00
TL 56 14M 85	48085056	18F	GG	56	3525	90	249,55	246,76	256		210	102	65	18,5	416	19,00
TL 64 14M 85	48085064	19F	GG	64	3525	90	285,21	282,41	296	190	240	102	65	18,5	418	23,50
TL 72 14M 85	48085072	19	GG	72	3525	90	320,86	318,06		190	280	102	65	18,5		25,00
TL 80 14M 85	48085080	20	GG	80	3525	90	356,51	353,71		190	315	102	65	18,5		26,00
TL 90 14M 85	48085090	20	GG	90	3525	90	401,07	398,28		190	360	102	65	18,5		28,00
TL112 14M 85	48085112	20	GG	112	3525	90	499,11	496,32		190	457	102	65	18,5		36,00
TL144 14M 85	48085144	20	GG	144	3525	90	641,71	638,92		190	600	102	65	18,5		48,00
TL168 14M 85	48085168	20	GG	168	3525	90	748,66	745,87		190	706	102	65	18,5		60,00
TL192 14M 85	48085192	22	GG	192	4040	100	855,62	852,82		230	813	102	102			85,00



# PULEGGE DENTATE A BUSSOLA CONICA PER CINGHIE HTD®

## HTD® TIMING BELT PULLEYS FOR TAPER BUSHES

# 14M

## PASSO 14 mm

PER CINGHIE LARGHEZZA 115 mm

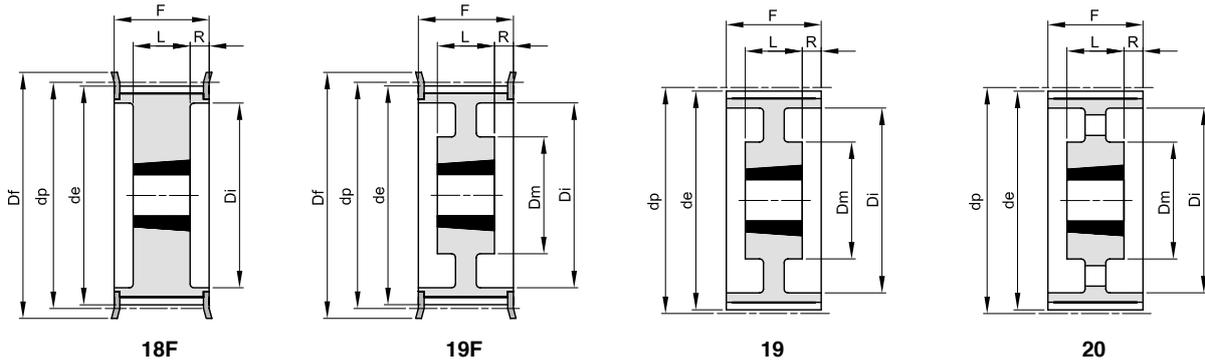

Materiale: Acciaio (St)  
Materiale: Ghisa (GG)

descrizione	codice	tipo	materiale	denti	bussola	foro max	dp	de	Df	Dm	Di	F	L	R	n° flangia	Kg.
TL 28 14M 115	48115028	18F	St	28	2517	60	124,78	122,12	127		98	133	45	44	400	3,80
TL 30 14M 115	48115030	18F	St	30	2517	60	133,69	130,99	138		100	133	45	44	401	5,00
TL 32 14M 115	48115032	18F	St	32	2517	60	142,60	139,88	154		108	133	45	44	403	6,80
TL 34 14M 115	48115034	18F	St	34	2517	60	151,52	148,79	160		110	133	45	44	404	6,90
TL 36 14M 115	48115036	18F	St	36	3020	75	160,43	157,68	168		125	133	51	41	405	7,00
TL 38 14M 115	48115038	18F	St	38	3020	75	169,34	166,60	183		130	133	51	41	406	8,50
TL 40 14M 115	48115040	18F	St	40	3020	75	178,25	175,49	188		138	133	51	41	407	9,10
TL 44 14M 115	48115044	18F	St	44	3030	75	196,08	193,28	211		155	133	76	28,5	411	13,00
TL 48 14M 115	48115048	18F	St	48	3030	75	213,90	211,11	226		170	133	76	28,5	412	16,00
TL 56 14M 115	48115056	18F	GG	56	3535	90	249,55	246,76	256		210	133	89	22	416	24,00
TL 64 14M 115	48115064	19F	GG	64	3535	90	285,21	282,41	296	190	240	133	89	22	418	32,00
TL 72 14M 115	48115072	19	GG	72	3535	90	320,86	318,06		190	280	133	89	22		31,00
TL 80 14M 115	48115080	20	GG	80	3535	90	356,51	353,71		190	315	133	89	22		32,00
TL 90 14M 115	48115090	20	GG	90	3535	90	401,07	398,28		190	360	133	89	22		37,00
TL112 14M 115	48115112	20	GG	112	3535	90	499,11	496,32		190	457	133	89	22		45,00
TL144 14M 115	48115144	20	GG	144	4040	100	641,71	638,92		230	600	133	102	15,5		63,00
TL168 14M 115	48115168	20	GG	168	4040	100	748,66	745,87		230	706	133	102	15,5		77,50
TL192 14M 115	48115192	20	GG	192	4040	100	855,62	852,82		230	813	133	102	15,5		95,00



# PULEGGE DENTATE A BUSSOLA CONICA PER CINGHIE HTD®

## HTD® TIMING BELT PULLEYS FOR TAPER BUSHES

### 14M

PASSO 14 mm

PER CINGHIE LARGHEZZA 170 mm

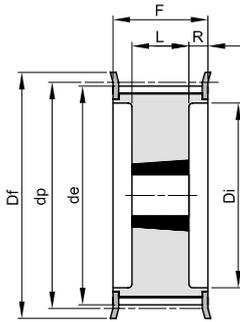

18F

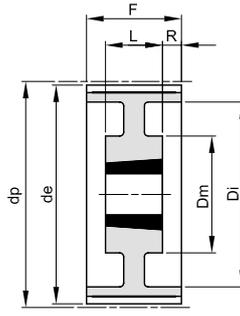

19

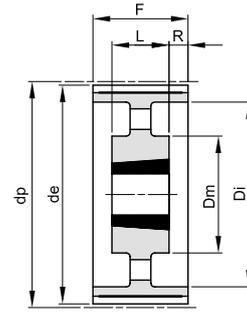

20

Materiale: Acciaio (St)  
Materiale: Ghisa (GG)

descrizione	codice	tipo	materiale	denti	bussola	foro max	dp	de	Df	Dm	Di	F	L	R	n° flangia	Kg.
TL 38 14M 170	48170038	18F	St	38	3030	75	169,34	166,60	183		130	187	76	55,5	406	11,70
TL 40 14M 170	48170040	18F	St	40	3030	75	178,25	175,49	188		138	187	76	55,5	407	13,00
TL 44 14M 170	48170044	18F	St	44	3535	90	196,08	193,28	211		155	187	89	49	411	15,00
TL 48 14M 170	48170048	18F	St	48	3535	90	213,90	211,11	226		170	187	89	49	412	19,00
TL 56 14M 170	48170056	18F	St	56	3535	90	249,55	246,76	256		210	187	89	49	416	28,50
TL 64 14M 170	48170064	18F	GG	64	4040	100	285,21	282,41	296		240	187	102	42,5	418	41,00
TL 72 14M 170	48170072	19	GG	72	4040	100	320,86	318,06		230	280	187	102	42,5		47,00
TL 80 14M 170	48170080	19	GG	80	4040	100	356,51	353,71		230	315	187	102	42,5		48,00
TL 90 14M 170	48170090	20	GG	90	4040	100	401,07	398,28		230	360	187	102	42,5		52,50
TL112 14M 170	48170112	20	GG	112	5050	125	499,11	496,32		265	457	187	127	30		74,50
TL144 14M 170	48170144	20	GG	144	5050	125	641,71	638,92		265	600	187	127	30		91,00
TL168 14M 170	48170168	20	GG	168	5050	125	748,66	745,87		265	706	187	127	30		116,00
TL192 14M 170	48170192	20	GG	192	5050	125	855,62	852,82		265	813	187	127	30		134,00



# PULEGGE DENTATE "PCB" A BUSSOLA CONICA PER CINGHIE SYNCHROCHAIN "PCB" SYNCHROCHAIN TIMING BELTS PULLEYS FOR TAPER BUSHES

## 8M

### PASSO 8 mm

PER CINGHIE LARGHEZZA 12 mm

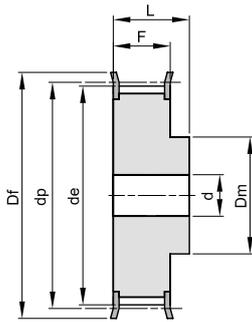

2F

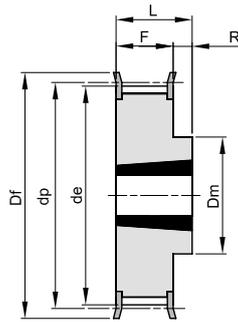

10F

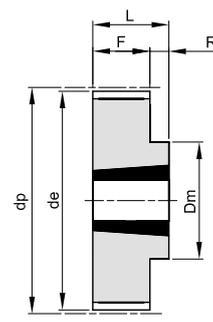

10

Materiale: Acciaio (St)  
Materiale: Ghisa (GG)

descrizione	codice	tipo	materiale	denti	buss.	foro max	dp	de	Df	Dm	Di	F	L	R	d	n° flangia	Kg.
8M 22S 12	PCB47012022	2F	St	22			56,02	54,42	60	43		20	30	10	12	308	0,43
TL 8M 25S 12	PCB47012025	10F	St	25	1108	28	63,66	62,06	66	49		20	22	2		310	0,25
TL 8M 28S 12	PCB47012028	10F	St	28	1108	28	71,30	69,70	75	56		20	22	2		312	0,37
TL 8M 30S 12	PCB47012030	10F	St	30	1210	32	76,39	74,79	83	60		20	25	5		314	0,41
TL 8M 32S 12	PCB47012032	10F	St	32	1610	42	81,49	79,89	87	66		20	25	5		315	0,43
TL 8M 34S 12	PCB47012034	10F	St	34	1610	42	86,58	84,98	91	68		20	25	5		316	0,45
TL 8M 36S 12	PCB47012036	10F	St	36	1610	42	91,67	90,07	98	74		20	25	5		319	0,59
TL 8M 38S 12	PCB47012038	10F	St	38	1610	42	96,77	95,17	103	80		20	25	5		320	0,70
TL 8M 40S 12	PCB47012040	10F	St	40	1610	42	101,86	100,26	106	85		20	25	5		321	0,82
TL 8M 45S 12	PCB47012045	10F	St	45	2012	50	114,59	112,99	119	92		20	32	12		325	1,10
TL 8M 48S 12	PCB47012048	10F	St	48	2012	50	122,23	120,63	127	100		20	32	12		327	1,42
TL 8M 50S 12	PCB47012050	10F	St	50	2012	50	127,32	125,72	135	104		20	32	12		328	1,60
TL 8M 56S 12	PCB47012056	10F	St	56	2012	50	142,60	141,00	148	104		20	32	12		333	2,10
TL 8M 60S 12	PCB47012060	10F	St	60	2012	50	152,79	151,19	158	111		20	32	12		335	2,40
TL 8M 64S 12	PCB47012064	10F	St	64	2012	50	162,97	161,37	168	111		20	32	12		338	2,70
TL 8M 75S 12	PCB47012075	10	GG	75	2012	50	190,99	189,39		111		20	32	12			3,70
TL 8M 80S 12	PCB47012080	10	GG	80	2012	50	203,72	202,12		111		20	32	12			4,40
TL 8M 90S 12	PCB47012090	10	GG	90	2012	50	229,18	227,58		111		20	32	12			5,50



# PULEGGE DENTATE "PCB" A BUSSOLA CONICA PER CINGHIE SYNCHROCHAIN "PCB" SYNCHROCHAIN TIMING BELTS PULLEYS FOR TAPER BUSHES

## 8M

### PASSO 8 mm

PER CINGHIE LARGHEZZA 21 mm

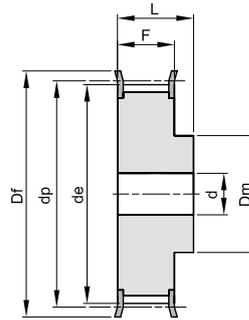

2F

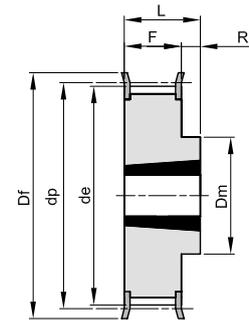

10F

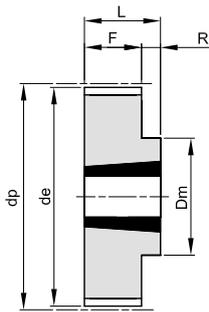

10

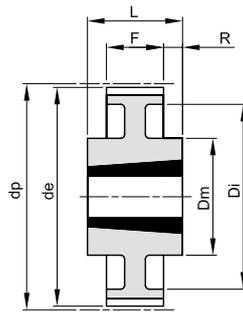

13

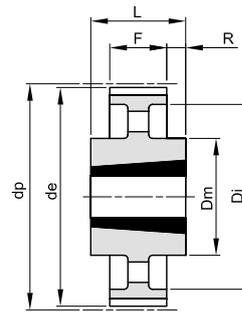

14

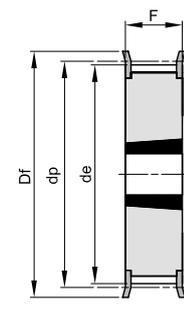

15F

Materiale: Acciaio (St)  
Materiale: Ghisa (GG)

descrizione	codice	tipo	materiale	denti	buss.	foro max	dp	de	Df	Dm	Di	F	L	R	d	n° flangia	Kg.
8M 22S 21	PCB47021022	2F	St	22			56,02	54,42	60	43		30	40	10	12	308	0,56
TL 8M 25S 21	PCB47021025	15F	St	25	1108	28	63,66	62,06	66			30				310	0,36
TL 8M 28S 21	PCB47021028	15F	St	28	1210	32	71,30	69,70	75			30				312	0,41
TL 8M 30S 21	PCB47021030	15F	St	30	1210	32	76,39	74,79	83			30				314	0,56
TL 8M 32S 21	PCB47021032	15F	St	32	1610	42	81,49	79,89	87			30				315	0,52
TL 8M 34S 21	PCB47021034	15F	St	34	1610	42	86,58	84,98	91			30				316	0,61
TL 8M 36S 21	PCB47021036	15F	St	36	1610	42	91,67	90,07	98			30				319	0,70
TL 8M 38S 21	PCB47021038	15F	St	38	1610	42	96,77	95,17	103			30				320	0,92
TL 8M 40S 21	PCB47021040	15F	St	40	1610	42	101,86	100,26	106			30				321	1,06
TL 8M 45S 21	PCB47021045	10F	St	45	2012	50	114,59	112,99	119	92		30	32	2		325	1,30
TL 8M 48S 21	PCB47021048	10F	St	48	2012	50	122,23	120,63	127	100		30	32	2		327	1,60
TL 8M 50S 21	PCB47021050	10F	St	50	2012	50	127,32	125,72	135	104		30	32	2		328	1,83
TL 8M 56S 21	PCB47021056	10F	St	56	2012	50	142,60	141,00	148	111		30	32	2		333	2,40
TL 8M 60S 21	PCB47021060	10F	St	60	2517	65	152,79	151,19	158	124		30	45	15		335	3,20
TL 8M 64S 21	PCB47021064	10F	St	64	2517	65	162,97	161,37	168	124		30	45	15		338	3,80
TL 8M 75S 21	PCB47021075	10	GG	75	2517	65	190,99	189,39		124		30	45	15			6,20
TL 8M 80S 21	PCB47021080	10	GG	80	2517	65	203,72	202,12		124		30	45	15			6,00
TL 8M 90S 21	PCB47021090	13	GG	90	2517	65	229,18	227,58		124	198	30	45	7,5			5,40
TL 8M 112S 21	PCB47021112	13	GG	112	2517	65	285,21	283,61		124	253	30	45	7,5			7,40
TL 8M 140S 21	PCB47021140	14	GG	140	3020	75	356,51	354,91		150	324	30	51	10,5			9,00



# PULEGGE DENTATE "PCB" A BUSSOLA CONICA PER CINGHIE SYNCHROCHAIN "PCB" SYNCHROCHAIN TIMING BELTS PULLEYS FOR TAPER BUSHES

## 8M

### PASSO 8 mm

PER CINGHIE LARGHEZZA 36 mm

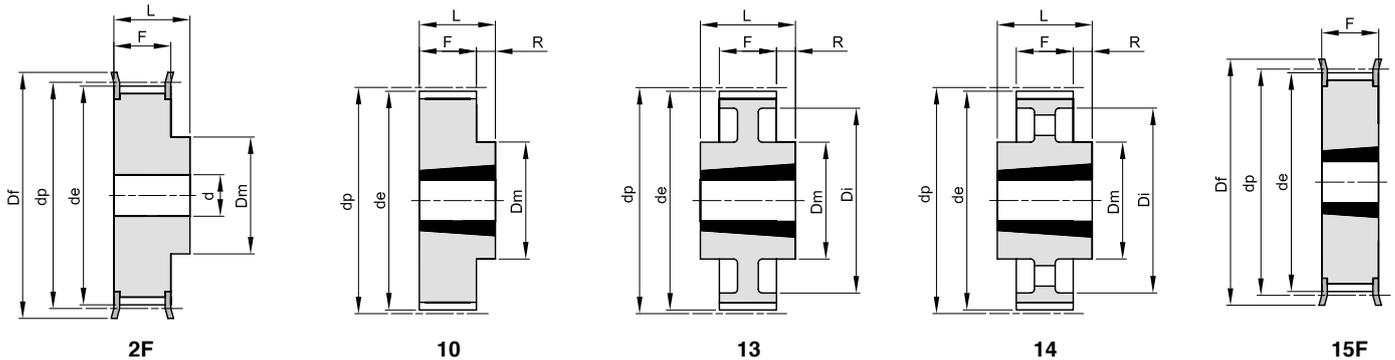

Materiale: Acciaio (St)  
Materiale: Ghisa (GG)

descrizione	codice	tipo	materiale	denti	buss.	foro max	dp	de	Df	Dm	Di	F	L	R	d	n° flangia	Kg.
8M 25S 36	PCB47036025	2F	St	25			63,66	62,06	66	49		45	55		12	310	1,40
TL 8M 28S 36	PCB47036028	15F	St	28	1210	32	71,30	69,70	75			45				312	0,64
TL 8M 30S 36	PCB47036030	15F	St	30	1610	42	76,39	74,79	83			45				314	0,59
TL 8M 32S 36	PCB47036032	15F	St	32	1610	42	81,49	79,89	87			45				315	0,79
TL 8M 34S 36	PCB47036034	15F	St	34	1610	42	86,58	84,98	91			45				316	0,63
TL 8M 36S 36	PCB47036036	15F	St	36	1610	42	91,67	90,07	98			45				319	1,15
TL 8M 38S 36	PCB47036038	15F	St	38	1610	42	96,77	95,17	103			45				320	1,39
TL 8M 40S 36	PCB47036040	15F	St	40	2012	50	101,86	100,26	106			45				321	1,34
TL 8M 45S 36	PCB47036045	15F	St	45	2012	50	114,59	112,99	119			45				325	1,87
TL 8M 48S 36	PCB47036048	15F	St	48	2012	50	122,23	120,63	127			45				327	2,20
TL 8M 50S 36	PCB47036050	15F	St	50	2012	50	127,32	125,72	135			45				328	2,70
TL 8M 56S 36	PCB47036056	15F	St	56	2517	65	142,60	141,00	148			45				333	3,00
TL 8M 60S 36	PCB47036060	15F	St	60	2517	65	152,79	151,19	158			45				335	3,80
TL 8M 64S 36	PCB47036064	15F	St	64	2517	65	162,97	161,37	168			45				338	4,50
TL 8M 75S 36	PCB47036075	10	GG	75	3020	75	190,99	189,39		150		45	51	6			6,20
TL 8M 80S 36	PCB47036080	10	GG	80	3020	75	203,72	202,12		150		45	51	6			7,40
TL 8M 90S 36	PCB47036090	13	GG	90	3020	75	229,18	227,58		150	197	45	51	3			7,20
TL 8M 112S 36	PCB47036112	13	GG	112	3020	75	285,21	283,61		150	253	45	51	3			10,40
TL 8M 140S 36	PCB47036140	14	GG	140	3020	75	356,51	354,91		150	324	45	51	3			12,70
TL 8M 168S 36	PCB47036168	14	GG	168	3525	90	427,81	426,21		198	396	45	65	10			21,50
TL 8M 192S 36	PCB47036192	14	GG	192	3525	90	488,92	487,32		198	457	45	65	10			27,00



# PULEGGE DENTATE "PCB" A BUSSOLA CONICA PER CINGHIE SYNCHROCHAIN "PCB" SYNCHROCHAIN TIMING BELTS PULLEYS FOR TAPER BUSHES

## 8M

### PASSO 8 mm

PER CINGHIE LARGHEZZA 62 mm

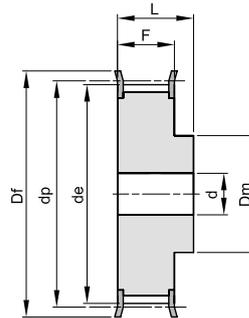

2F

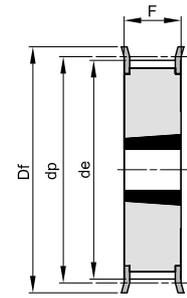

15F

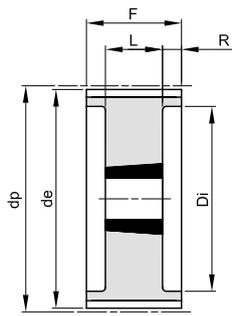

18

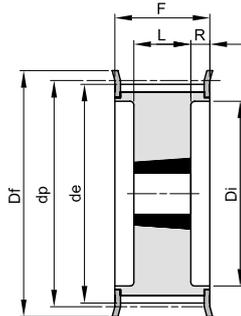

18F

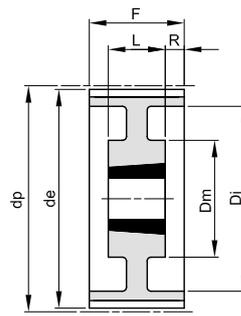

19

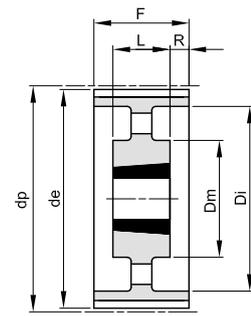

20

Materiale: Acciaio (St)  
Materiale: Ghisa (GG)

descrizione	codice	tipo	materiale	denti	buss.	foro max	dp	de	Df	Dm	Di	F	L	R	d	n° flangia	Kg.
8M 30S 62	PCB47062030	2F	St	30			76,39	74,79	83	62		72	84	15	314	2,40	
8M 32S 62	PCB47062032	2F	St	32			81,49	79,89	87	65		72	84	15	315	2,80	
8M 34S 62	PCB47062034	2F	St	34			86,58	84,98	91	70		72	84	15	316	3,00	
8M 36S 62	PCB47062036	2F	St	36			91,67	90,07	98	75		72	84	15	319	3,40	
8M 38S 62	PCB47062038	2F	St	38			96,77	95,17	103	75		72	84	15	320	3,80	
TL 8M 40S 62	PCB47062040	15F	St	40	2012	50	101,86	100,26	106			72				321	2,06
TL 8M 45S 62	PCB47062045	15F	St	45	2012	50	114,59	112,99	119			72				325	3,00
TL 8M 48S 62	PCB47062048	15F	St	48	2517	65	122,23	120,63	127			72				327	2,90
TL 8M 50S 62	PCB47062050	15F	St	50	2517	65	127,32	125,72	135			72				328	3,25
TL 8M 56S 62	PCB47062056	18F	St	56	2517	65	142,60	141,00	148		111	72	45	13,5		333	3,90
TL 8M 60S 62	PCB47062060	18F	St	60	2517	65	152,79	151,19	158		121	72	45	13,5		335	4,70
TL 8M 64S 62	PCB47062064	18F	St	64	2517	65	162,97	161,37	168		131	72	45	13,5		338	5,60
TL 8M 75S 62	PCB47062075	18	GG	75	3020	75	190,99	189,39			159	72	51	10,5			7,50
TL 8M 80S 62	PCB47062080	18	GG	80	3020	75	203,72	202,12			172	72	51	10,5			9,20
TL 8M 90S 62	PCB47062090	18	GG	90	3020	75	229,18	227,58			197	72	51	10,5			7,70
TL 8M 112S 62	PCB47062112	19	GG	112	3020	75	285,21	283,61		150	253	72	51	10,5			12,10
TL 8M 140S 62	PCB47062140	19	GG	140	3525	90	356,51	354,91		198	324	72	65	3,5			22,70
TL 8M 168S 62	PCB47062168	20	GG	168	3525	90	427,81	426,21		198	396	72	65	3,5			26,80
TL 8M 192S 62	PCB47062192	20	GG	192	3525	90	488,92	487,32		198	457	72	65	3,5			34,20



# PULEGGE DENTATE "PCB" A BUSSOLA CONICA PER CINGHIE SYNCHROCHAIN "PCB" SYNCHROCHAIN TIMING BELTS PULLEYS FOR TAPER BUSHES

## 14M

### PASSO 14 mm

PER CINGHIE LARGHEZZA 20 mm

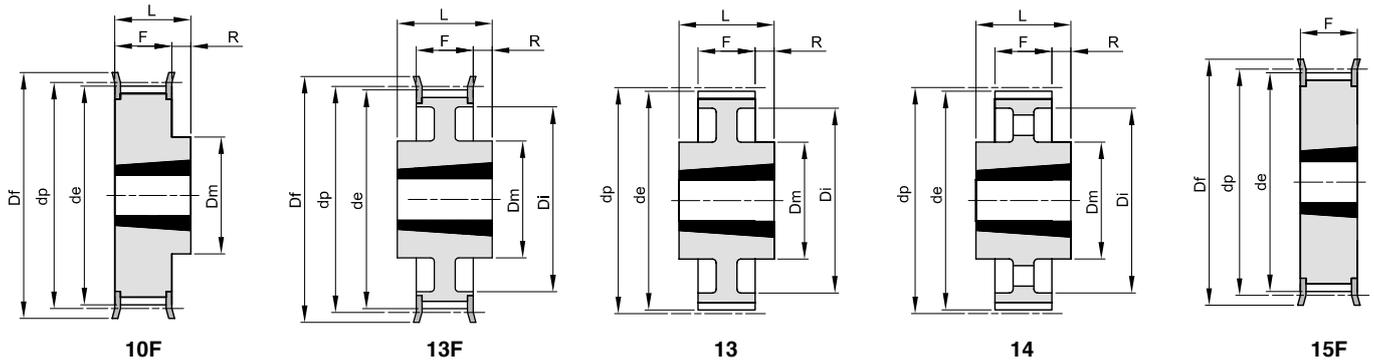

Materiale: Acciaio (St)  
Materiale: Ghisa (GG)

descrizione	codice	tipo	materiale	denti	buss.	foro max	dp	de	Df	Dm	Di	F	L	R	d	n° flangia	Kg.
TL 14M 28S 20	PCB48020028	15F	St	28	2012	50	124,78	121,98	127			33				400	1,66
TL 14M 30S 20	PCB48020030	15F	St	30	2012	50	133,69	130,89	138			33				401	2,20
TL 14M 32S 20	PCB48020032	15F	St	32	2012	50	142,60	139,80	154			33				403	3,20
TL 14M 34S 20	PCB48020034	10F	St	34	2517	65	151,52	148,72	160	117		33	45	12		404	3,00
TL 14M 36S 20	PCB48020036	10F	St	36	2517	65	160,43	157,63	168	117		33	45	12		405	3,60
TL 14M 38S 20	PCB48020038	10F	St	38	2517	65	169,34	166,54	183	117		33	45	12		406	4,00
TL 14M 40S 20	PCB48020040	10F	St	40	2517	65	178,25	175,45	188	117		33	45	12		407	4,70
TL 14M 44S 20	PCB48020044	10F	St	44	3020	75	196,08	193,28	211	144		33	51	18		411	5,60
TL 14M 48S 20	PCB48020048	10F	St	48	3020	75	213,90	211,11	226	144		33	51	18		412	6,80
TL 14M 50S 20	PCB48020050	10F	GG	50	3020	75	222,82	220,02	240	144		33	51	18		414	7,70
TL 14M 56S 20	PCB48020056	13F	GG	56	3020	75	249,55	246,76	256	144	207	33	51	9		416	7,70
TL 14M 60S 20	PCB48020060	13	GG	60	3020	75	267,38	264,58		159	224	33	51	9			8,50
TL 14M 64S 20	PCB48020064	13	GG	64	3020	75	285,21	282,41		159	242	33	51	9			10,20
TL 14M 72S 20	PCB48020072	13	GG	72	3020	75	320,86	318,06		159	278	33	51	9			11,50
TL 14M 80S 20	PCB48020080	13	GG	80	3020	75	356,51	353,71		159	314	33	51	9			13,50
TL 14M 90S 20	PCB48020090	14	GG	90	3020	75	401,07	398,27		159	360	33	51	9			14,20
TL 14M 112S 20	PCB48020112	14	GG	112	3020	75	499,11	496,31		159	456	33	51	9			18,10
TL 14M 140S 20	PCB48020140	14	GG	140	3020	75	623,89	621,09		159	581	33	51	9			22,90



# PULEGGE DENTATE "PCB" A BUSSOLA CONICA PER CINGHIE SYNCHROCHAIN "PCB" SYNCHROCHAIN TIMING BELTS PULLEYS FOR TAPER BUSHES

## 14M

### PASSO 14 mm

PER CINGHIE LARGHEZZA 37 mm

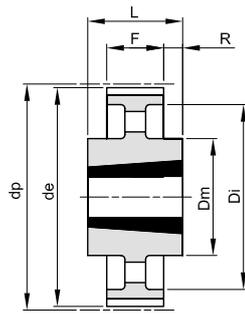

14

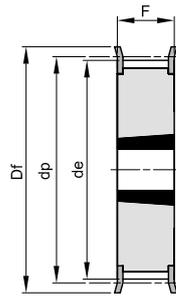

15F

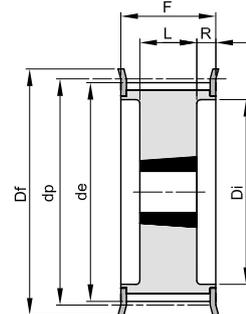

18F

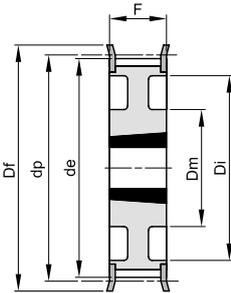

21F

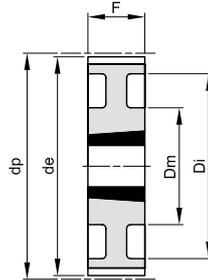

21

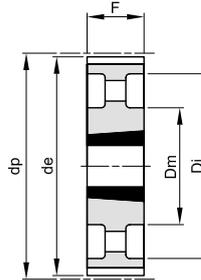

22

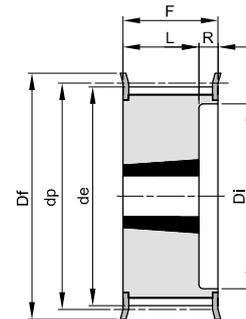

23F

Materiale: Acciaio (St)  
Materiale: Ghisa (GG)

descrizione	codice	tipo	materiale	denti	buss.	foro max	dp	de	Df	Dm	Di	F	L	R	d	n° flangia	Kg.
TL 14M 28S 37	PCB48037028	23F	St	28	2012	50	124,78	121,98	127		88	51	32	19		400	2,20
TL 14M 30S 37	PCB48037030	18F	St	30	2517	65	133,69	130,89	138		98	51	45	3		401	2,50
TL 14M 32S 37	PCB48037032	18F	St	32	2517	65	142,60	139,80	154		100	51	45	3		403	3,00
TL 14M 34S 37	PCB48037034	18F	St	34	2517	65	151,52	148,72	160		109	51	45	3		404	3,80
TL 14M 36S 37	PCB48037036	23F	St	36	2517	65	160,43	157,63	168		117	51	45	6		405	4,30
TL 14M 38S 37	PCB48037038	23F	St	38	2517	65	169,34	166,54	183		126	51	45	6		406	5,10
TL 14M 40S 37	PCB48037040	23F	St	40	2517	65	178,25	175,45	188		135	51	45	6		407	6,00
TL 14M 44S 37	PCB48037044	15F	St	44	3020	75	196,08	193,28	211			51				411	7,00
TL 14M 48S 37	PCB48037048	15F	St	48	3020	75	213,90	211,11	226			51				412	9,00
TL 14M 50S 37	PCB48037050	15F	GG	50	3020	75	222,82	220,02	240			51				414	10,00
TL 14M 56S 37	PCB48037056	21F	GG	56	3020	75	249,55	246,76	256	144	207	51				416	9,20
TL 14M 60S 37	PCB48037060	21	GG	60	3020	75	267,38	264,58		159	224	51					10,20
TL 14M 64S 37	PCB48037064	21	GG	64	3020	75	285,21	282,41		159	242	51					12,20
TL 14M 72S 37	PCB48037072	21	GG	72	3020	75	320,86	318,06		159	278	51					13,40
TL 14M 80S 37	PCB48037080	21	GG	80	3020	75	356,51	353,71		159	314	51					16,10
TL 14M 90S 37	PCB48037090	22	GG	90	3020	75	401,07	398,27		159	360	51					17,20
TL 14M 112S 37	PCB48037112	22	GG	112	3020	75	499,11	496,31		159	456	51					23,00
TL 14M 140S 37	PCB48037140	14	GG	140	3525	90	623,89	621,09		206	581	51	65	7			41,00
TL 14M 168S 37	PCB48037168	14	GG	168	3525	90	748,66	745,87		206	706	51	65	7			51,50
TL 14M 192S 37	PCB48037192	14	GG	192	4030	90	855,61	852,82		215	812	51	76	12,5			60,00



# PULEGGE DENTATE "PCB" A BUSSOLA CONICA PER CINGHIE SYNCHROCHAIN "PCB" SYNCHROCHAIN TIMING BELTS PULLEYS FOR TAPER BUSHES

## 14M

### PASSO 14 mm

PER CINGHIE LARGHEZZA 68 mm

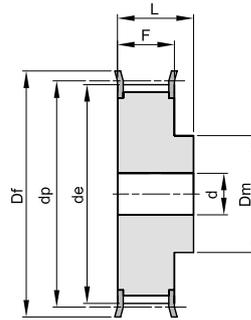

2F

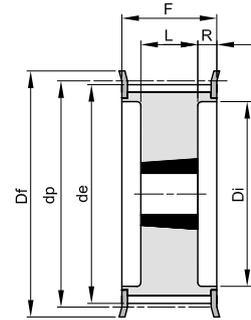

18F

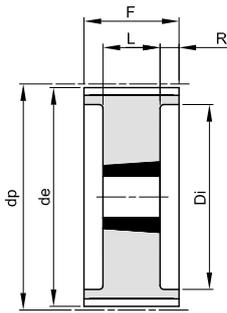

18

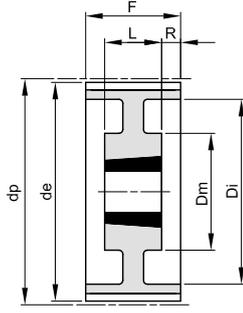

19

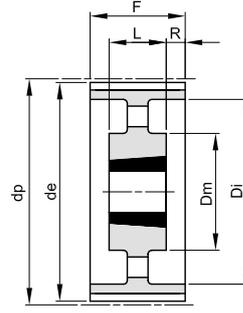

20

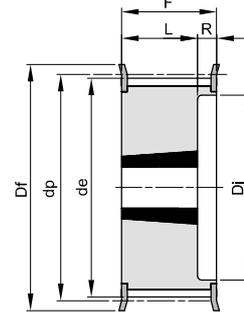

23F

Materiale: Acciaio (St)  
Materiale: Ghisa (GG)

descrizione	codice	tipo	materiale	denti	buss.	foro max	dp	de	Df	Dm	Di	F	L	R	d	n° flangia	Kg.
14M 34S 68	PCB48068034	2F	St	34			151,52	148,72	160	131		84	104	32	404	10,50	
14M 36S 68	PCB48068036	2F	St	36			160,43	157,63	168	131		84	104	32	405	11,70	
14M 38S 68	PCB48068038	2F	St	38			169,34	166,54	183	141		84	104	32	406	13,40	
14M 40S 68	PCB48068040	2F	St	40			178,25	175,45	188	155		84	104	32	407	15,40	
TL 14M 44S 68	PCB48068044	18F	St	44	3020	75	196,08	193,28	211		153	84	51	16,5		411	9,20
TL 14M 48S 68	PCB48068048	23F	St	48	3020	75	213,90	211,11	226		171	84	51	33		412	11,30
TL 14M 50S 68	PCB48068050	18F	GG	50	3525	90	222,82	220,02	240		180	84	65	9,5		414	15,50
TL 14M 56S 68	PCB48068056	18F	GG	56	3525	90	249,55	246,76	256		207	84	65	9,5		416	16,80
TL 14M 60S 68	PCB48068060	18	GG	60	3525	90	267,38	264,58			224	84	65	9,5			20,40
TL 14M 64S 68	PCB48068064	18	GG	64	3525	90	285,21	282,41			242	84	65	9,5			23,60
TL 14M 72S 68	PCB48068072	19	GG	72	3525	90	320,86	318,06		178	278	84	65	9,5			20,30
TL 14M 80S 68	PCB48068080	20	GG	80	3525	90	356,51	353,71		178	314	84	65	9,5			21,30
TL 14M 90S 68	PCB48068090	20	GG	90	3525	90	401,07	398,27		178	360	84	65	9,5			24,40
TL 14M 112S 68	PCB48068112	20	GG	112	3525	90	499,11	496,31		178	456	84	65	9,5			32,70
TL 14M 140S 68	PCB48068140	20	GG	140	3525	90	623,89	621,09		206	581	84	65	9,5			55,00
TL 14M 168S 68	PCB48068168	20	GG	168	3525	90	748,66	745,87		206	706	84	65	9,5			71,00
TL 14M 192S 68	PCB48068192	20	GG	192	4030	90	855,61	852,82		215	812	84	76	4			80,50



# PULEGGE DENTATE "PCB" A BUSSOLA CONICA PER CINGHIE SYNCHROCHAIN "PCB" SYNCHROCHAIN TIMING BELTS PULLEYS FOR TAPER BUSHES

## 14M

### PASSO 14 mm

PER CINGHIE LARGHEZZA 90 mm

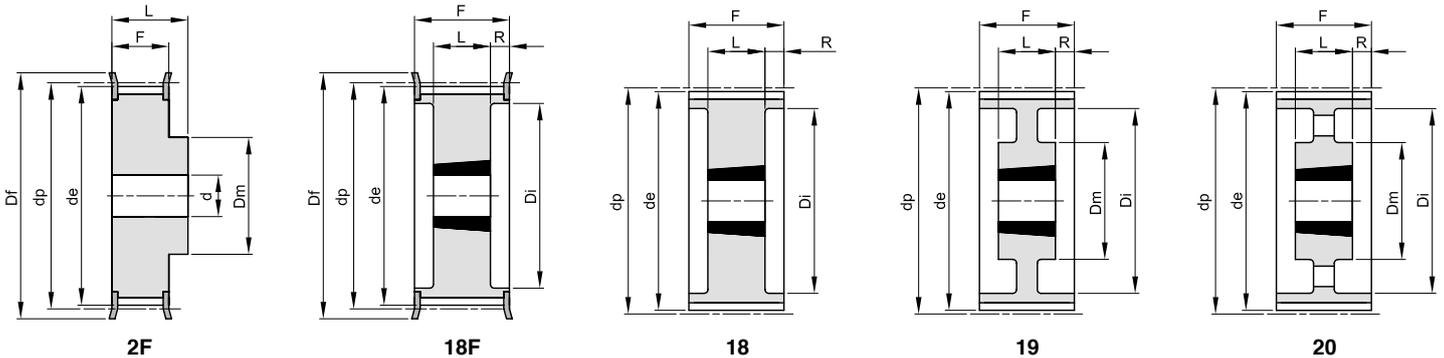

Materiale: Acciaio (St)  
Materiale: Ghisa (GG)

descrizione	codice	tipo	materiale	denti	buss.	foro max	dp	de	Df	Dm	Di	F	L	R	d	n° flangia	Kg.
14M 36S 90	PCB48090036	2F	St	36			160,43	157,63	168	131		106	136		32	405	14,5
14M 38S 90	PCB48090038	2F	St	38			169,34	166,54	183	141		106	136		32	406	17,5
14M 40S 90	PCB48090040	2F	St	40			178,25	175,45	188	155		106	136		32	407	19,1
14M 44S 90	PCB48090044	2F	St	44			196,08	193,28	211	167		106	136		32	411	23,9
TL 14M 48S 90	PCB48090048	18F	St	48	3525	90	213,90	211,11	226		171	106	66	20		412	12,7
TL 14M 50S 90	PCB48090050	18F	GG	50	3525	90	222,82	220,02	240		180	106	66	20		414	14,5
TL 14M 56S 90	PCB48090056	18F	GG	56	3525	90	249,55	246,76	256		207	106	66	20		416	19,0
TL 14M 60S 90	PCB48090060	18	GG	60	3525	90	267,38	264,58			224	106	66	20			22,5
TL 14M 64S 90	PCB48090064	18	GG	64	3525	90	285,21	282,41			242	106	66	20			24,0
TL 14M 72S 90	PCB48090072	19	GG	72	3525	90	320,86	318,06		178	278	106	66	20			22,6
TL 14M 80S 90	PCB48090080	19	GG	80	4030	90	356,51	353,71		215	314	106	76	15			27,0
TL 14M 90S 90	PCB48090090	19	GG	90	4030	90	401,07	398,27		215	360	106	76	15			34,1
TL 14M 112S 90	PCB48090112	20	GG	112	4535	120	499,11	496,31		215	456	106	90	8			46,0
TL 14M 140S 90	PCB48090140	20	GG	140	4535	120	623,89	621,09		215	581	106	90	8			61,0
TL 14M 168S 90	PCB48090168	20	GG	168	5040	125	748,66	745,87		267	706	106	102	2			90,0
TL 14M 192S 90	PCB48090192	20	GG	192	5040	125	855,61	852,82		267	812	106	102	2			108,5



# PULEGGE DENTATE "PCB" A BUSSOLA CONICA PER CINGHIE SYNCHROCHAIN "PCB" SYNCHROCHAIN TIMING BELTS PULLEYS FOR TAPER BUSHES

## 14M

### PASSO 14 mm

PER CINGHIE LARGHEZZA 125 mm

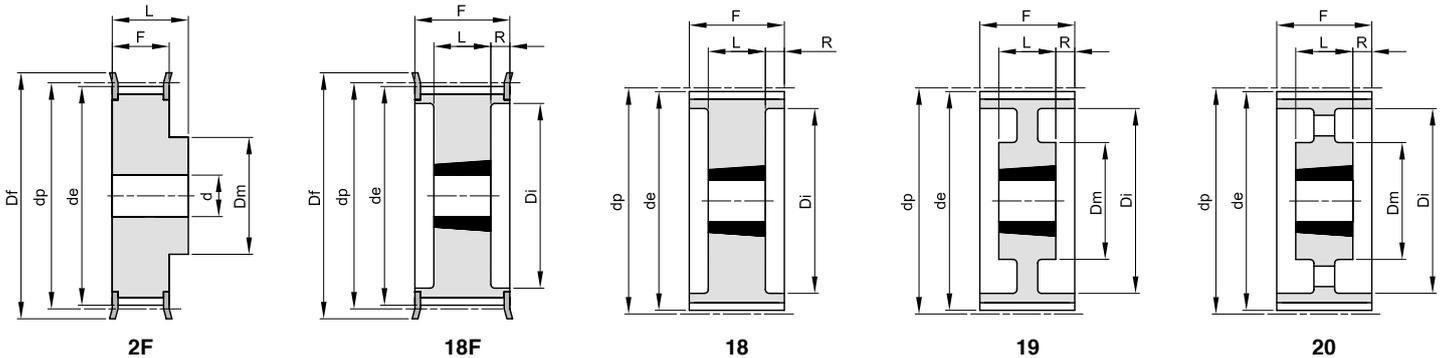

Materiale: Acciaio (St)  
Materiale: Ghisa (GG)

descrizione	codice	tipo	materiale	denti	buss.	foro max	dp	de	Df	Dm	Di	F	L	R	d	n° flangia	Kg.
14M 38S 125	PCB48125038	2F	St	38			169,34	166,54	183	141	141	161	32	406	20,3		
14M 40S 125	PCB48125040	2F	St	40			178,25	175,45	188	155	141	161	32	407	23,0		
14M 44S 125	PCB48125044	2F	St	44			196,08	193,28	211	167	141	161	32	411	28,8		
14M 48S 125	PCB48125048	2F	St	48			213,90	211,11	226	185	141	161	32	412	34,6		
TL 14M 50S 125	PCB48125050	18F	GG	50	3525	90	222,82	220,02	240		180	141	65	38	414	16,8	
TL 14M 56S 125	PCB48125056	18F	GG	56	3525	90	249,55	246,76	256		207	141	65	38	416	21,6	
TL 14M 60S 125	PCB48125060	18	GG	60	4030	90	267,38	264,58			224	141	76	32,5		25,6	
TL 14M 64S 125	PCB48125064	18	GG	64	4030	90	285,21	282,41			242	141	76	32,5		29,7	
TL 14M 72S 125	PCB48125072	19	GG	72	4030	90	320,86	318,06		215	278	141	76	32,5		30,0	
TL 14M 80S 125	PCB48125080	19	GG	80	4030	90	356,51	353,71		215	314	141	76	32,5		33,4	
TL 14M 90S 125	PCB48125090	19	GG	90	4030	90	401,07	398,27		215	360	141	76	32,5		39,4	
TL 14M 112S 125	PCB48125112	20	GG	112	4535	120	499,11	496,31		215	456	141	89	26		56,0	
TL 14M 140S 125	PCB48125140	20	GG	140	4535	120	623,89	621,09		215	581	141	89	26		73,0	
TL 14M 168S 125	PCB48125168	20	GG	168	5040	125	748,66	745,87		267	706	141	102	19,5		101,0	
TL 14M 192S 125	PCB48125192	20	GG	192	5040	125	855,61	852,82		267	802	141	102	19,5		121,5	





# PULEGGE DENTATE PASSO METRICO SERIE "T" - DIN 7721-2

## METRIC PULLEYS "T" - DIN 7721-2

### T 2,5

#### PASSO 2,5 mm

PER CINGHIE LARGHEZZA 6 mm

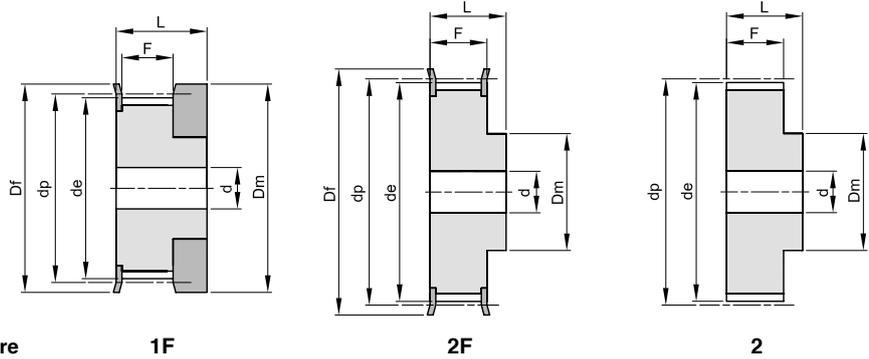

Materiale: Alluminio UNI 9006 - T6 (Al)  
adatto per l'ossidazione dura a spessore

descrizione	codice	tipo	materiale	denti	de	Df	Dm	F	L	d	n° flangia	Kg.
16 T 2,5 12	26006012	1F	Al	12	9,00	13	12	9	16		100	0,01
16 T 2,5 14	26006014	1F	Al	14	10,60	15	14	9	16		101	0,01
16 T 2,5 15	26006015	1F	Al	15	11,40	15	15	9	16		101	0,01
16 T 2,5 16	26006016	1F	Al	16	12,20	16	16	9	16		102	0,01
16 T 2,5 18	26006018	2F	Al	18	13,80	18	10	10	16		104	0,01
16 T 2,5 19	26006019	2F	Al	19	14,60	18	10	10	16		104	0,01
16 T 2,5 20	26006020	2F	Al	20	15,40	19,5	11	10	16		105	0,01
16 T 2,5 22	26006022	2F	Al	22	17,00	23	11	10	16		106	0,01
16 T 2,5 24	26006024	2F	Al	24	18,55	23	12	10	16		107	0,01
16 T 2,5 25	26006025	2F	Al	25	19,35	23	13	10	16		107	0,01
16 T 2,5 26	26006026	2F	Al	26	20,15	25	14	10	16		108	0,01
16 T 2,5 28	26006028	2F	Al	28	21,75	25	14	10	16		108	0,02
16 T 2,5 30	26006030	2F	Al	30	23,35	28	16	10	16	6	109	0,02
16 T 2,5 32	26006032	2F	Al	32	24,95	32	16	10	16	6	110	0,02
16 T 2,5 36	26006036	2F	Al	36	28,10	36	20	10	16	6	111	0,03
16 T 2,5 40	26006040	2F	Al	40	31,30	38	22	10	16	6	112	0,03
16 T 2,5 44	26006044	2	Al	44	34,50		24	10	16	6		0,04
16 T 2,5 48	26006048	2	Al	48	37,70		26	10	16	6		0,05
16 T 2,5 60	26006060	2	Al	60	47,25		34	10	16	8		0,07



# PULEGGE DENTATE PASSO METRICO SERIE "T" - DIN 7721-2

## METRIC PULLEYS "T" - DIN 7721-2

### T 5

#### PASSO 5 mm

PER CINGHIE LARGHEZZA 10 mm

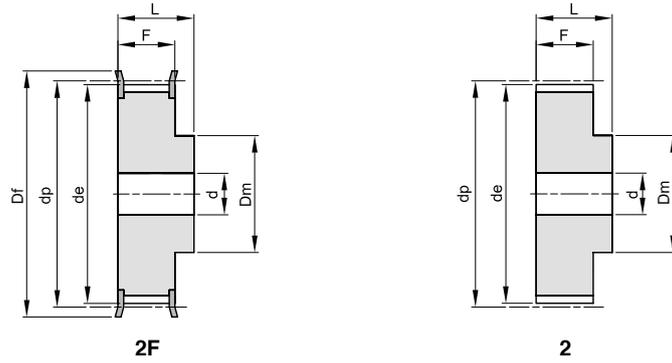

Materiale: Alluminio UNI 9006 - T6 (Al)  
adatto per l'ossidazione dura a spessore

descrizione	codice	tipo	materiale	denti	de	Df	Dm	F	L	d	n° flangia	Kg.
21 T 5 10	27010010	2F	Al	10	15,05	19,5	8	15	21		200	0,01
21 T 5 12	27010012	2F	Al	12	18,25	23	10	15	21		201	0,01
21 T 5 14	27010014	2F	Al	14	21,45	25	13	15	21		203	0,02
21 T 5 15	27010015	2F	Al	15	23,05	28	16	15	21		204	0,02
21 T 5 16	27010016	2F	Al	16	24,60	32	18	15	21		205	0,03
21 T 5 18	27010018	2F	Al	18	27,80	32	20	15	21		205	0,03
21 T 5 19	27010019	2F	Al	19	29,40	36	22	15	21		206	0,04
21 T 5 20	27010020	2F	Al	20	31,00	36	23	15	21		206	0,04
21 T 5 22	27010022	2F	Al	22	34,25	38	24	15	21		207	0,05
21 T 5 24	27010024	2F	Al	24	37,40	42	26	15	21		208	0,06
21 T 5 25	27010025	2F	Al	25	38,95	44	26	15	21		209	0,06
21 T 5 26	27010026	2F	Al	26	40,60	44	26	15	21		209	0,06
21 T 5 27	27010027	2F	Al	27	42,20	48	30	15	21	8	210	0,07
21 T 5 28	27010028	2F	Al	28	43,75	48	32	15	21	8	210	0,07
21 T 5 30	27010030	2F	Al	30	46,95	51	34	15	21	8	211	0,07
21 T 5 32	27010032	2F	Al	32	50,10	54	38	15	21	8	212	0,09
21 T 5 36	27010036	2F	Al	36	56,45	63	38	15	21	8	215	0,11
21 T 5 40	27010040	2F	Al	40	62,85	66	40	15	21	8	216	0,14
21 T 5 42	27010042	2F	Al	42	66,00	71	40	15	21	8	217	0,18
21 T 5 44	27010044	2	Al	44	69,20		45	15	21	8		0,18
21 T 5 48	27010048	2	Al	48	75,55		50	15	21	8		0,20
21 T 5 60	27010060	2	Al	60	94,65		65	15	21	8		0,31



# PULEGGE DENTATE PASSO METRICO SERIE "T" - DIN 7721-2

## METRIC PULLEYS "T" - DIN 7721-2

### T 5

#### PASSO 5 mm

PER CINGHIE LARGHEZZA 16 mm

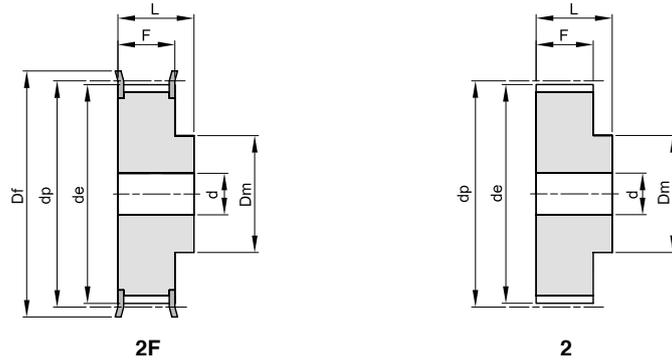

Materiale: Alluminio UNI 9006 - T6 (Al)  
adatto per l'ossidazione dura a spessore

descrizione	codice	tipo	materiale	denti	de	Df	Dm	F	L	d	n° flangia	Kg.
27 T 5 10	27016010	2F	Al	10	15,05	19,5	8	21	27		200	0,02
27 T 5 12	27016012	2F	Al	12	18,25	23	10	21	27		201	0,02
27 T 5 14	27016014	2F	Al	14	21,45	25	13	21	27		203	0,03
27 T 5 15	27016015	2F	Al	15	23,05	28	16	21	27		204	0,03
27 T 5 16	27016016	2F	Al	16	24,60	32	18	21	27		205	0,04
27 T 5 18	27016018	2F	Al	18	27,80	32	20	21	27		205	0,04
27 T 5 19	27016019	2F	Al	19	29,40	36	22	21	27		206	0,05
27 T 5 20	27016020	2F	Al	20	31,00	36	23	21	27		206	0,06
27 T 5 22	27016022	2F	Al	22	34,25	38	24	21	27		207	0,06
27 T 5 24	27016024	2F	Al	24	37,40	42	26	21	27		208	0,08
27 T 5 25	27016025	2F	Al	25	38,95	44	26	21	27		209	0,08
27 T 5 26	27016026	2F	Al	26	40,60	44	26	21	27		209	0,09
27 T 5 27	27016027	2F	Al	27	42,20	48	30	21	27	8	210	0,09
27 T 5 28	27016028	2F	Al	28	43,75	48	32	21	27	8	210	0,09
27 T 5 30	27016030	2F	Al	30	46,95	51	34	21	27	8	211	0,10
27 T 5 32	27016032	2F	Al	32	50,10	54	38	21	27	8	212	0,12
27 T 5 36	27016036	2F	Al	36	56,45	63	38	21	27	8	215	0,16
27 T 5 40	27016040	2F	Al	40	62,85	66	40	21	27	8	216	0,19
27 T 5 42	27016042	2F	Al	42	66,00	71	40	21	27	8	217	0,20
27 T 5 44	27016044	2	Al	44	69,20		45	21	27	8		0,23
27 T 5 48	27016048	2	Al	48	75,55		50	21	27	8		0,28
27 T 5 60	27016060	2	Al	60	94,65		65	21	27	8		0,43



# PULEGGE DENTATE PASSO METRICO SERIE "T" - DIN 7721-2

## METRIC PULLEYS "T" - DIN 7721-2

### T 5

PASSO 5 mm

PER CINGHIE LARGHEZZA 25 mm

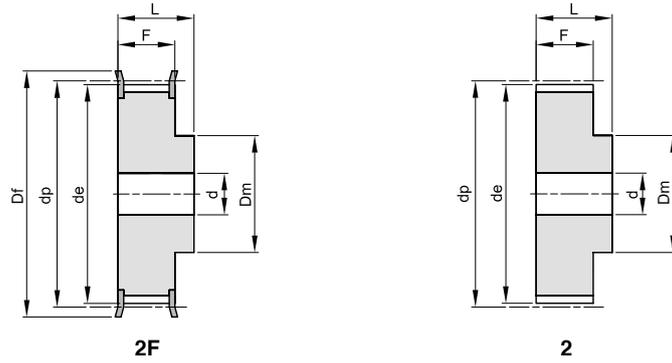

Materiale: Alluminio UNI 9006 - T6 (Al)  
adatto per l'ossidazione dura a spessore

descrizione	codice	tipo	materiale	denti	de	Df	Dm	F	L	d	n° flangia	Kg.
36 T 5 10	27025010	2F	Al	10	15,05	19,5	8	30	36		200	0,02
36 T 5 12	27025012	2F	Al	12	18,25	23	10	30	36		201	0,03
36 T 5 14	27025014	2F	Al	14	21,45	25	13	30	36		203	0,04
36 T 5 15	27025015	2F	Al	15	23,05	28	16	30	36		204	0,04
36 T 5 16	27025016	2F	Al	16	24,60	32	18	30	36		205	0,05
36 T 5 18	27025018	2F	Al	18	27,80	32	20	30	36		205	0,06
36 T 5 19	27025019	2F	Al	19	29,40	36	22	30	36		206	0,07
36 T 5 20	27025020	2F	Al	20	31,00	36	23	30	36		206	0,08
36 T 5 22	27025022	2F	Al	22	34,25	38	24	30	36		207	0,08
36 T 5 24	27025024	2F	Al	24	37,40	42	26	30	36		208	0,11
36 T 5 25	27025025	2F	Al	25	38,95	44	26	30	36		209	0,12
36 T 5 26	27025026	2F	Al	26	40,60	44	26	30	36		209	0,12
36 T 5 27	27025027	2F	Al	27	42,20	48	30	30	36	8	210	0,13
36 T 5 28	27025028	2F	Al	28	43,75	48	32	30	36	8	210	0,14
36 T 5 30	27025030	2F	Al	30	46,95	51	34	30	36	8	211	0,15
36 T 5 32	27025032	2F	Al	32	50,10	54	38	30	36	8	212	0,18
36 T 5 36	27025036	2F	Al	36	56,45	63	38	30	36	8	215	0,23
36 T 5 40	27025040	2F	Al	40	62,85	66	40	30	36	8	216	0,28
36 T 5 42	27025042	2F	Al	42	66,00	71	40	30	36	8	217	0,29
36 T 5 44	27025044	2	Al	44	69,20		45	30	36	8		0,31
36 T 5 48	27025048	2	Al	48	75,55		50	30	36	8		0,40
36 T 5 60	27025060	2	Al	60	94,65		65	30	36	8		0,61



# PULEGGE DENTATE PASSO METRICO SERIE "T" - DIN 7721-2

## METRIC PULLEYS "T" - DIN 7721-2

### T 10

#### PASSO 10 mm

PER CINGHIE LARGHEZZA 16 mm

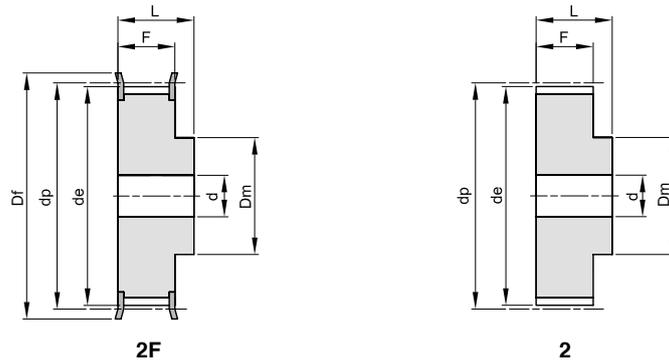

Materiale: Alluminio UNI 9006 - T6 (Al)  
adatto per l'ossidazione dura a spessore

descrizione	codice	tipo	materiale	denti	de	Df	Dm	F	L	d	n° flangia	Kg.
31 T 10 12	28016012	2F	Al	12	36,35	42	28	21	31	6	208	0,08
31 T 10 14	28016014	2F	Al	14	42,70	48	32	21	31	8	210	0,10
31 T 10 15	28016015	2F	Al	15	45,90	51	32	21	31	8	211	0,12
31 T 10 16	28016016	2F	Al	16	49,10	54	35	21	31	8	212	0,13
31 T 10 18	28016018	2F	Al	18	55,45	60	40	21	31	8	214	0,17
31 T 10 19	28016019	2F	Al	19	58,65	66	44	21	31	8	216	0,18
31 T 10 20	28016020	2F	Al	20	61,80	66	46	21	31	8	216	0,21
31 T 10 22	28016022	2F	Al	22	68,20	75	52	21	31	8	218	0,25
31 T 10 24	28016024	2F	Al	24	74,55	83	58	21	31	8	219	0,29
31 T 10 25	28016025	2F	Al	25	77,75	83	60	21	31	8	219	0,31
31 T 10 26	28016026	2F	Al	26	80,90	87	60	21	31	8	220	0,36
31 T 10 27	28016027	2F	Al	27	84,10	91	60	21	31	8	221	0,37
31 T 10 28	28016028	2F	Al	28	87,25	93	60	21	31	8	222	0,40
31 T 10 30	28016030	2F	Al	30	93,65	97	60	21	31	8	223	0,44
31 T 10 32	28016032	2F	Al	32	100,00	106	65	21	31	10	224	0,49
31 T 10 36	28016036	2F	Al	36	112,75	119	70	21	31	10	225	0,62
31 T 10 40	28016040	2F	Al	40	125,45	131	80	21	31	10	226	0,77
31 T 10 44	28016044	2	Al	44	138,20		88	21	31	10		1,00
31 T 10 48	28016048	2	Al	48	150,95		95	21	31	16		1,10
31 T 10 60	28016060	2	Al	60	189,15		110	21	31	16		1,70



# PULEGGE DENTATE PASSO METRICO SERIE "T" - DIN 7721-2

## METRIC PULLEYS "T" - DIN 7721-2

### T 10

#### PASSO 10 mm

PER CINGHIE LARGHEZZA 25 mm

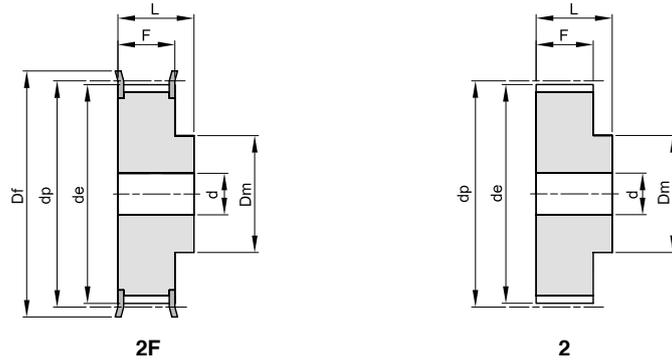

Materiale: Alluminio UNI 9006 - T6 (Al)  
adatto per l'ossidazione dura a spessore

descrizione	codice	tipo	materiale	denti	de	Df	Dm	F	L	d	n° flangia	Kg.
40 T 10 12	28025012	2F	Al	12	36,35	42	28	30	40	6	208	0,10
40 T 10 14	28025014	2F	Al	14	42,70	48	32	30	40	8	210	0,13
40 T 10 15	28025015	2F	Al	15	45,90	51	32	30	40	8	211	0,15
40 T 10 16	28025016	2F	Al	16	49,10	54	35	30	40	8	212	0,18
40 T 10 18	28025018	2F	Al	18	55,45	60	40	30	40	8	214	0,22
40 T 10 19	28025019	2F	Al	19	58,65	66	44	30	40	8	216	0,25
40 T 10 20	28025020	2F	Al	20	61,80	66	46	30	40	8	216	0,28
40 T 10 22	28025022	2F	Al	22	68,20	75	52	30	40	8	218	0,34
40 T 10 24	28025024	2F	Al	24	74,55	83	58	30	40	8	219	0,39
40 T 10 25	28025025	2F	Al	25	77,75	83	60	30	40	8	219	0,42
40 T 10 26	28025026	2F	Al	26	80,90	87	60	30	40	8	220	0,48
40 T 10 27	28025027	2F	Al	27	84,10	91	60	30	40	8	221	0,54
40 T 10 28	28025028	2F	Al	28	87,25	93	60	30	40	8	222	0,55
40 T 10 30	28025030	2F	Al	30	93,65	97	60	30	40	8	223	0,64
40 T 10 32	28025032	2F	Al	32	100,00	106	65	30	40	10	224	0,69
40 T 10 36	28025036	2F	Al	36	112,75	119	70	30	40	10	225	0,87
40 T 10 40	28025040	2F	Al	40	125,45	131	80	30	40	10	226	1,07
40 T 10 44	28025044	2	Al	44	138,20		88	30	40	10		1,35
40 T 10 48	28025048	2	Al	48	150,95		95	30	40	16		1,52
40 T 10 60	28025060	2	Al	60	189,15		110	30	40	16		2,34



# PULEGGE DENTATE PASSO METRICO SERIE "T" - DIN 7721-2

## METRIC PULLEYS "T" - DIN 7721-2

### T 10

PASSO 10 mm

PER CINGHIE LARGHEZZA 32 mm

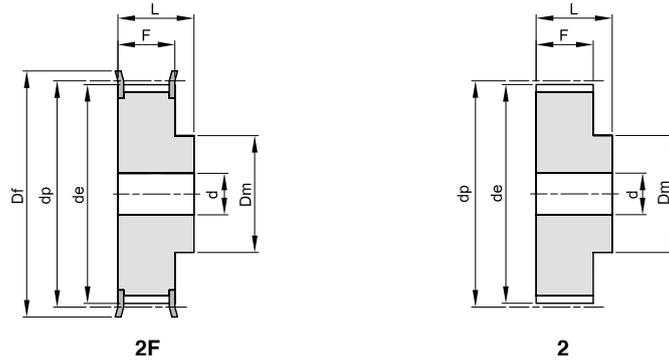

Materiale: Alluminio UNI 9006 - T6 (Al)  
adatto per l'ossidazione dura a spessore

descrizione	codice	tipo	materiale	denti	de	Df	Dm	F	L	d	n° flangia	Kg.
47 T 10 18	28032018	2F	Al	18	55,45	60	40	37	47	10	214	0,25
47 T 10 19	28032019	2F	Al	19	58,65	66	44	37	47	10	216	0,29
47 T 10 20	28032020	2F	Al	20	61,80	66	46	37	47	12	216	0,32
47 T 10 22	28032022	2F	Al	22	68,20	75	52	37	47	12	218	0,39
47 T 10 24	28032024	2F	Al	24	74,55	83	58	37	47	12	219	0,47
47 T 10 25	28032025	2F	Al	25	77,75	83	60	37	47	12	219	0,53
47 T 10 26	28032026	2F	Al	26	80,90	87	60	37	47	12	220	0,56
47 T 10 27	28032027	2F	Al	27	84,10	91	60	37	47	12	221	0,60
47 T 10 28	28032028	2F	Al	28	87,25	93	60	37	47	12	222	0,64
47 T 10 30	28032030	2F	Al	30	93,65	97	60	37	47	12	223	0,74
47 T 10 32	28032032	2F	Al	32	100,00	106	65	37	47	12	224	0,84
47 T 10 36	28032036	2F	Al	36	112,75	119	70	37	47	16	225	1,06
47 T 10 40	28032040	2F	Al	40	125,45	131	80	37	47	16	226	1,32
47 T 10 44	28032044	2	Al	44	138,20		88	37	47	16		1,61
47 T 10 48	28032048	2	Al	48	150,95		95	37	47	16		1,93
47 T 10 60	28032060	2	Al	60	189,10		110	37	47	16		3,00



# PULEGGE DENTATE PASSO METRICO SERIE "T" - DIN 7721-2

## METRIC PULLEYS "T" - DIN 7721-2

### T 10

#### PASSO 10 mm

PER CINGHIE LARGHEZZA 50 mm

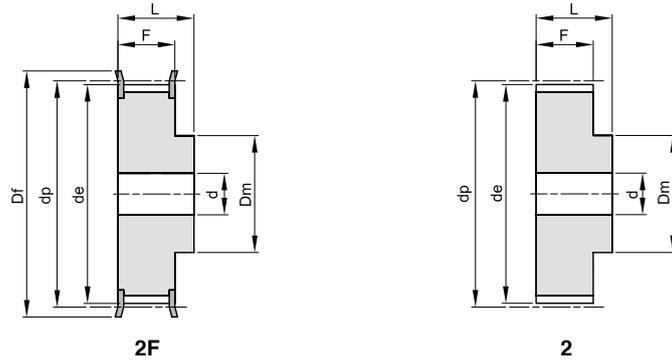

Materiale: Alluminio UNI 9006 - T6 (Al)  
adatto per l'ossidazione dura a spessore

descrizione	codice	tipo	materiale	denti	de	Df	Dm	F	L	d	n° flangia	Kg.
66 T 10 18	28050018	2F	Al	18	55,45	60	40	56	66	10	214	0,42
66 T 10 19	28050019	2F	Al	19	58,65	66	44	56	66	10	216	0,47
66 T 10 20	28050020	2F	Al	20	61,80	66	46	56	66	12	216	0,52
66 T 10 22	28050022	2F	Al	22	68,20	75	52	56	66	12	218	0,57
66 T 10 24	28050024	2F	Al	24	74,55	83	58	56	66	12	219	0,74
66 T 10 25	28050025	2F	Al	25	77,75	83	60	56	66	12	219	0,77
66 T 10 26	28050026	2F	Al	26	80,90	87	60	56	66	12	220	0,82
66 T 10 27	28050027	2F	Al	27	84,10	91	60	56	66	12	221	0,95
66 T 10 28	28050028	2F	Al	28	87,25	93	60	56	66	12	222	0,96
66 T 10 30	28050030	2F	Al	30	93,65	97	60	56	66	12	223	1,17
66 T 10 32	28050032	2F	Al	32	100,00	106	65	56	66	12	224	1,30
66 T 10 36	28050036	2F	Al	36	112,75	119	70	56	66	16	225	1,64
66 T 10 40	28050040	2F	Al	40	125,45	131	80	56	66	16	226	2,00
66 T 10 44	28050044	2	Al	44	138,20		88	56	66	16		2,36
66 T 10 48	28050048	2	Al	48	150,95		95	56	66	16		2,83
66 T 10 60	28050060	2	Al	60	189,10		110	56	66	16		4,37



# PULEGGE DENTATE PASSO METRICO SERIE BAT PER CINGHIE "AT" METRIC PULLEYS "AT"

## BAT 5

PASSO 5 mm

PER CINGHIE AT LARGHEZZA 10 mm

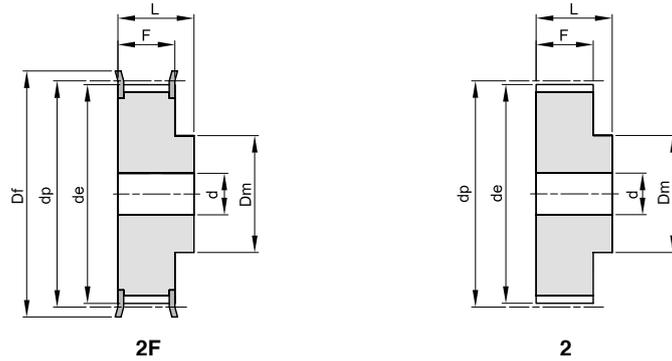

Materiale: Alluminio UNI 9006 - T6 (Al)  
adatto per l'ossidazione dura a spessore

descrizione	codice	tipo	materiale	denti	de	Df	Dm	F	L	d	n° flangia	Kg.
21 BAT 5 12	60021012	2F	Al	12	17,85	23	10	15	21		201	0,01
21 BAT 5 14	60021014	2F	Al	14	21,05	25	13	15	21		203	0,02
21 BAT 5 15	60021015	2F	Al	15	22,65	28	16	15	21		204	0,02
21 BAT 5 16	60021016	2F	Al	16	24,20	32	18	15	21		205	0,03
21 BAT 5 18	60021018	2F	Al	18	27,40	32	20	15	21		205	0,03
21 BAT 5 19	60021019	2F	Al	19	29,00	36	22	15	21		206	0,04
21 BAT 5 20	60021020	2F	Al	20	30,60	36	23	15	21		206	0,04
21 BAT 5 22	60021022	2F	Al	22	33,85	38	24	15	21		207	0,05
21 BAT 5 24	60021024	2F	Al	24	37,00	42	26	15	21		208	0,06
21 BAT 5 25	60021025	2F	Al	25	38,55	44	26	15	21		209	0,06
21 BAT 5 26	60021026	2F	Al	26	40,20	44	26	15	21		209	0,06
21 BAT 5 27	60021027	2F	Al	27	41,80	48	30	15	21	8	210	0,07
21 BAT 5 28	60021028	2F	Al	28	43,35	48	32	15	21	8	210	0,07
21 BAT 5 30	60021030	2F	Al	30	46,55	51	34	15	21	8	211	0,07
21 BAT 5 32	60021032	2F	Al	32	49,70	54	38	15	21	8	212	0,09
21 BAT 5 36	60021036	2F	Al	36	56,05	63	38	15	21	8	215	0,11
21 BAT 5 40	60021040	2F	Al	40	62,45	66	40	15	21	8	216	0,14
21 BAT 5 42	60021042	2F	Al	42	65,60	71	40	15	21	8	217	0,18
21 BAT 5 44	60021044	2	Al	44	68,80		45	15	21	8		0,18
21 BAT 5 48	60021048	2	Al	48	75,15		50	15	21	8		0,20
21 BAT 5 60	60021060	2	Al	60	94,25		65	15	21	8		0,31



# PULEGGE DENTATE PASSO METRICO SERIE BAT PER CINGHIE "AT" METRIC PULLEYS "AT"

## BAT 5

PASSO 5 mm

PER CINGHIE AT LARGHEZZA 16 mm

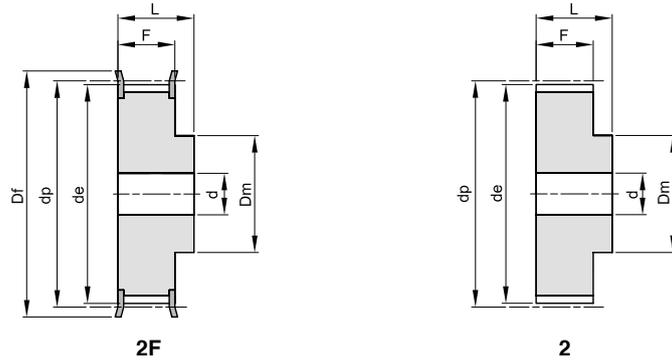

Materiale: Alluminio UNI 9006 - T6 (Al)  
adatto per l'ossidazione dura a spessore

descrizione	codice	tipo	materiale	denti	de	Df	Dm	F	L	d	n° flangia	Kg.
27 BAT 5 12	60027012	2F	Al	12	17,85	23	10	21	27		201	0,02
27 BAT 5 14	60027014	2F	Al	14	21,05	25	13	21	27		203	0,03
27 BAT 5 15	60027015	2F	Al	15	22,65	28	16	21	27		204	0,03
27 BAT 5 16	60027016	2F	Al	16	24,20	32	18	21	27		205	0,04
27 BAT 5 18	60027018	2F	Al	18	27,40	32	20	21	27		205	0,04
27 BAT 5 19	60027019	2F	Al	19	29,00	36	22	21	27		206	0,05
27 BAT 5 20	60027020	2F	Al	20	30,60	36	23	21	27		206	0,06
27 BAT 5 22	60027022	2F	Al	22	33,85	38	24	21	27		207	0,06
27 BAT 5 24	60027024	2F	Al	24	37,00	42	26	21	27		208	0,08
27 BAT 5 25	60027025	2F	Al	25	38,55	44	26	21	27		209	0,08
27 BAT 5 26	60027026	2F	Al	26	40,20	44	26	21	27		209	0,09
27 BAT 5 27	60027027	2F	Al	27	41,80	48	30	21	27	8	210	0,09
27 BAT 5 28	60027028	2F	Al	28	43,35	48	32	21	27	8	210	0,09
27 BAT 5 30	60027030	2F	Al	30	46,55	51	34	21	27	8	211	0,10
27 BAT 5 32	60027032	2F	Al	32	49,70	54	38	21	27	8	212	0,12
27 BAT 5 36	60027036	2F	Al	36	56,05	63	38	21	27	8	215	0,16
27 BAT 5 40	60027040	2F	Al	40	62,45	66	40	21	27	8	216	0,19
27 BAT 5 42	60027042	2F	Al	42	65,60	71	40	21	27	8	217	0,20
27 BAT 5 44	60027044	2	Al	44	68,80		45	21	27	8		0,23
27 BAT 5 48	60027048	2	Al	48	75,15		50	21	27	8		0,28
27 BAT 5 60	60027060	2	Al	60	94,25		65	21	27	8		0,43



# PULEGGE DENTATE PASSO METRICO SERIE BAT PER CINGHIE "AT" METRIC PULLEYS "AT"

## BAT 5

PASSO 5 mm

PER CINGHIE AT LARGHEZZA 25 mm

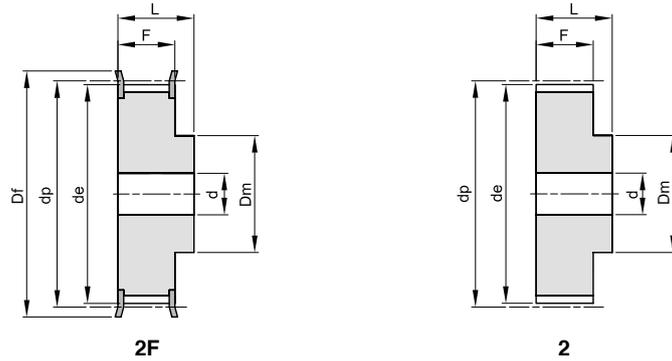

Materiale: Alluminio UNI 9006 - T6 (Al)  
adatto per l'ossidazione dura a spessore

descrizione	codice	tipo	materiale	denti	de	Df	Dm	F	L	d	n° flangia	Kg.
36 BAT 5 12	60036012	2F	Al	12	17,85	23	10	30	36		201	0,03
36 BAT 5 14	60036014	2F	Al	14	21,05	25	13	30	36		203	0,04
36 BAT 5 15	60036015	2F	Al	15	22,65	28	16	30	36		204	0,04
36 BAT 5 16	60036016	2F	Al	16	24,20	32	18	30	36		205	0,05
36 BAT 5 18	60036018	2F	Al	18	27,40	32	20	30	36		205	0,06
36 BAT 5 19	60036019	2F	Al	19	29,00	36	22	30	36		206	0,07
36 BAT 5 20	60036020	2F	Al	20	30,60	36	23	30	36		206	0,08
36 BAT 5 22	60036022	2F	Al	22	33,85	38	24	30	36		207	0,08
36 BAT 5 24	60036024	2F	Al	24	37,00	42	26	30	36	8	208	0,11
36 BAT 5 25	60036025	2F	Al	25	38,55	44	26	30	36	8	209	0,12
36 BAT 5 26	60036026	2F	Al	26	40,20	44	26	30	36	8	209	0,12
36 BAT 5 27	60036027	2F	Al	27	41,80	48	30	30	36	8	210	0,13
36 BAT 5 28	60036028	2F	Al	28	43,35	48	32	30	36	8	210	0,14
36 BAT 5 30	60036030	2F	Al	30	46,55	51	34	30	36	8	211	0,15
36 BAT 5 32	60036032	2F	Al	32	49,70	54	38	30	36	8	212	0,18
36 BAT 5 36	60036036	2F	Al	36	56,05	63	38	30	36	8	215	0,23
36 BAT 5 40	60036040	2F	Al	40	62,45	66	40	30	36	8	216	0,28
36 BAT 5 42	60036042	2F	Al	42	65,60	71	40	30	36	8	217	0,29
36 BAT 5 44	60036044	2	Al	44	68,80		45	30	36	8		0,31
36 BAT 5 48	60036048	2	Al	48	75,15		50	30	36	8		0,40
36 BAT 5 60	60036060	2	Al	60	94,25		65	30	36	8		0,61



# PULEGGE DENTATE PASSO METRICO SERIE BAT PER CINGHIE "AT" METRIC PULLEYS "AT"

## BAT 10

PASSO 10 mm

PER CINGHIE AT LARGHEZZA 16 mm

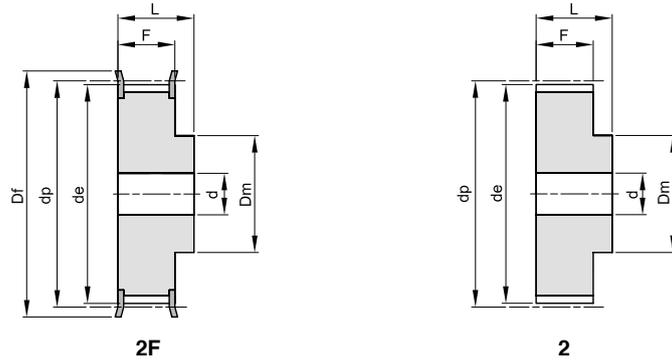

Materiale: Alluminio UNI 9006 - T6 (Al)  
adatto per l'ossidazione dura a spessore

descrizione	codice	tipo	materiale	denti	de	Df	Dm	F	L	d	n° flangia	Kg.
31 BAT 10 15	61031015	2F	Al	15	45,90	51	32	21	31	8	211	0,12
31 BAT 10 16	61031016	2F	Al	16	49,10	54	35	21	31	8	212	0,13
31 BAT 10 18	61031018	2F	Al	18	55,45	60	40	21	31	8	214	0,17
31 BAT 10 19	61031019	2F	Al	19	58,65	66	44	21	31	8	216	0,18
31 BAT 10 20	61031020	2F	Al	20	61,80	66	46	21	31	8	216	0,21
31 BAT 10 22	61031022	2F	Al	22	68,20	75	52	21	31	8	218	0,25
31 BAT 10 24	61031024	2F	Al	24	74,55	83	58	21	31	8	219	0,29
31 BAT 10 25	61031025	2F	Al	25	77,75	83	60	21	31	8	219	0,31
31 BAT 10 26	61031026	2F	Al	26	80,90	87	60	21	31	8	220	0,36
31 BAT 10 27	61031027	2F	Al	27	84,05	91	60	21	31	8	221	0,37
31 BAT 10 28	61031028	2F	Al	28	87,25	93	60	21	31	8	222	0,40
31 BAT 10 30	61031030	2F	Al	30	93,65	97	60	21	31	8	223	0,44
31 BAT 10 32	61031032	2F	Al	32	100,00	106	65	21	31	10	224	0,49
31 BAT 10 36	61031036	2F	Al	36	112,75	119	70	21	31	10	225	0,62
31 BAT 10 40	61031040	2F	Al	40	125,45	131	80	21	31	10	226	0,77
31 BAT 10 44	61031044	2	Al	44	138,20		88	21	31	10		1,00
31 BAT 10 48	61031048	2	Al	48	150,95		95	21	31	16		1,10
31 BAT 10 60	61031060	2	Al	60	189,15		110	21	31	16		1,70



# PULEGGE DENTATE PASSO METRICO SERIE BAT PER CINGHIE "AT" METRIC PULLEYS "AT"

## BAT 10

PASSO 10 mm

PER CINGHIE AT LARGHEZZA 25 mm

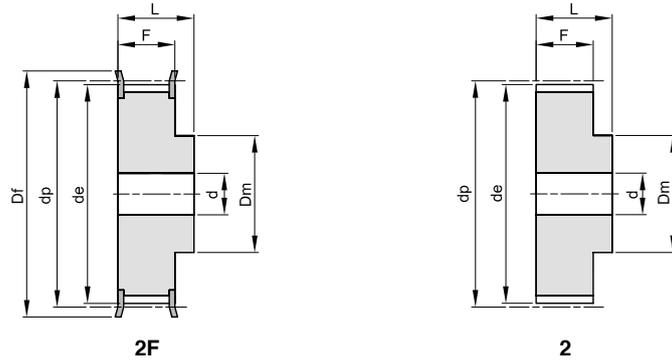

Materiale: Alluminio UNI 9006 - T6 (Al)  
adatto per l'ossidazione dura a spessore

descrizione	codice	tipo	materiale	denti	de	Df	Dm	F	L	d	n° flangia	Kg.
40 BAT 10 15	61040015	2F	Al	15	45,90	51	32	30	40	8	211	0,15
40 BAT 10 16	61040016	2F	Al	16	49,10	54	35	30	40	8	212	0,18
40 BAT 10 18	61040018	2F	Al	18	55,45	60	40	30	40	8	214	0,22
40 BAT 10 19	61040019	2F	Al	19	58,65	66	44	30	40	8	216	0,25
40 BAT 10 20	61040020	2F	Al	20	61,80	66	46	30	40	8	216	0,28
40 BAT 10 22	61040022	2F	Al	22	68,20	75	52	30	40	8	218	0,34
40 BAT 10 24	61040024	2F	Al	24	74,55	83	58	30	40	8	219	0,39
40 BAT 10 25	61040025	2F	Al	25	77,75	83	60	30	40	8	219	0,42
40 BAT 10 26	61040026	2F	Al	26	80,90	87	60	30	40	8	220	0,48
40 BAT 10 27	61040027	2F	Al	27	84,05	91	60	30	40	8	221	0,54
40 BAT 10 28	61040028	2F	Al	28	87,25	93	60	30	40	8	222	0,55
40 BAT 10 30	61040030	2F	Al	30	93,65	97	60	30	40	8	223	0,64
40 BAT 10 32	61040032	2F	Al	32	100,00	106	65	30	40	10	224	0,69
40 BAT 10 36	61040036	2F	Al	36	112,75	119	70	30	40	10	225	0,87
40 BAT 10 40	61040040	2F	Al	40	125,45	131	80	30	40	10	226	1,07
40 BAT 10 44	61040044	2	Al	44	138,20		88	30	40	10		1,35
40 BAT 10 48	61040048	2	Al	48	150,95		95	30	40	16		1,52
40 BAT 10 60	61040060	2	Al	60	189,15		110	30	40	16		2,34



# PULEGGE DENTATE PASSO METRICO SERIE BAT PER CINGHIE "AT" METRIC PULLEYS "AT"

## BAT 10

PASSO 10 mm

PER CINGHIE AT LARGHEZZA 32 mm

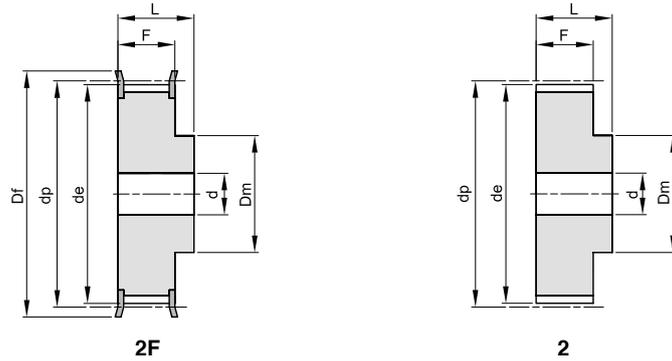

Materiale: Alluminio UNI 9006 - T6 (Al)  
adatto per l'ossidazione dura a spessore

descrizione	codice	tipo	materiale	denti	de	Df	Dm	F	L	d	n° flangia	Kg.
47 BAT 10 18	61047018	2F	Al	18	55,45	60	40	37	47	10	214	0,25
47 BAT 10 19	61047019	2F	Al	19	58,65	66	44	37	47	10	216	0,29
47 BAT 10 20	61047020	2F	Al	20	61,80	66	46	37	47	12	216	0,32
47 BAT 10 22	61047022	2F	Al	22	68,20	75	52	37	47	12	218	0,39
47 BAT 10 24	61047024	2F	Al	24	74,55	83	58	37	47	12	219	0,47
47 BAT 10 25	61047025	2F	Al	25	77,75	83	60	37	47	12	219	0,53
47 BAT 10 26	61047026	2F	Al	26	80,90	87	60	37	47	12	220	0,56
47 BAT 10 27	61047027	2F	Al	27	84,05	91	60	37	47	12	221	0,60
47 BAT 10 28	61047028	2F	Al	28	87,25	93	60	37	47	12	222	0,64
47 BAT 10 30	61047030	2F	Al	30	93,65	97	60	37	47	12	223	0,74
47 BAT 10 32	61047032	2F	Al	32	100,00	106	65	37	47	12	224	0,84
47 BAT 10 36	61047036	2F	Al	36	112,75	119	70	37	47	16	225	1,06
47 BAT 10 40	61047040	2F	Al	40	125,45	131	80	37	47	16	226	1,32
47 BAT 10 44	61047044	2	Al	44	138,20		88	37	47	16		1,61
47 BAT 10 48	61047048	2	Al	48	150,95		95	37	47	16		1,93
47 BAT 10 60	61047060	2	Al	60	189,15		110	37	47	16		3,00



# PULEGGE DENTATE PASSO METRICO SERIE BAT PER CINGHIE "AT" METRIC PULLEYS "AT"

## BAT 10

PASSO 10 mm

PER CINGHIE AT LARGHEZZA 50 mm

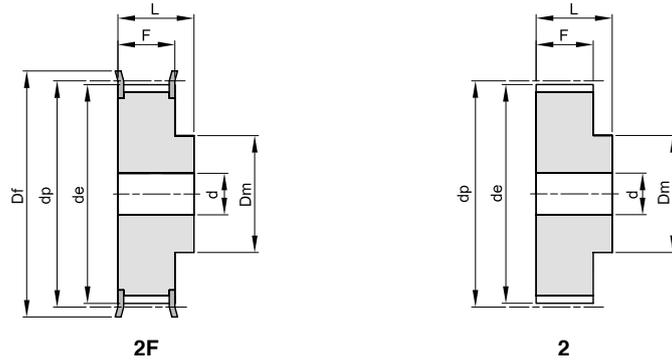

Materiale: Alluminio UNI 9006 - T6 (Al)  
adatto per l'ossidazione dura a spessore

descrizione	codice	tipo	materiale	denti	de	Df	Dm	F	L	d	n° flangia	Kg.
66 BAT 10 18	61066018	2F	Al	18	55,45	60	40	56	66	10	214	0,42
66 BAT 10 19	61066019	2F	Al	19	58,65	66	44	56	66	10	216	0,47
66 BAT 10 20	61066020	2F	Al	20	61,80	66	46	56	66	12	216	0,52
66 BAT 10 22	61066022	2F	Al	22	68,20	75	52	56	66	12	218	0,57
66 BAT 10 24	61066024	2F	Al	24	74,55	83	58	56	66	12	219	0,74
66 BAT 10 25	61066025	2F	Al	25	77,75	83	60	56	66	12	219	0,77
66 BAT 10 26	61066026	2F	Al	26	80,90	87	60	56	66	12	220	0,82
66 BAT 10 27	61066027	2F	Al	27	84,05	91	60	56	66	12	221	0,95
66 BAT 10 28	61066028	2F	Al	28	87,25	93	60	56	66	12	222	0,96
66 BAT 10 30	61066030	2F	Al	30	93,65	97	60	56	66	12	223	1,17
66 BAT 10 32	61066032	2F	Al	32	100,00	106	65	56	66	12	224	1,30
66 BAT 10 36	61066036	2F	Al	36	112,75	119	70	56	66	16	225	1,64
66 BAT 10 40	61066040	2F	Al	40	125,45	131	80	56	66	16	226	2,00
66 BAT 10 44	61066044	2	Al	44	138,20		88	56	66	16		2,36
66 BAT 10 48	61066048	2	Al	48	150,95		95	56	66	16		2,83
66 BAT 10 60	61066060	2	Al	60	189,15		110	56	66	16		4,37



# BARRE DENTATE PER CINGHIE POSITIVE - ISO 5294

## TIMING BELT BARS - ISO 5294

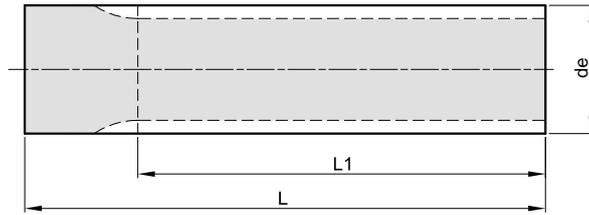

### MXL PASSO 0,080" (2,032 mm)

MATERIALE: ALLUMINIO UNI 9006 - T6

descrizione	codice	Z	de	L1	L	n° flangia adattabile	Kg.
MXL 12	22000012	12	7,25	50	75	100	0,01
MXL 14	22000014	14	8,55	50	75	100	0,01
MXL 15	22000015	15	9,19	50	75	100	0,01
MXL 16	22000016	16	9,84	50	75	101	0,02
MXL 18	22000018	18	11,13	50	75	102	0,02
MXL 20	22000020	20	12,43	90	120	102	0,04
MXL 22	22000022	22	13,72	125	140	104	0,05
MXL 24	22000024	24	15,02	125	140	104	0,06
MXL 25	22000025	25	15,66	125	140	105	0,07
MXL 26	22000026	26	16,31	125	140	106	0,08
MXL 28	22000028	28	17,60	125	140	107	0,09
MXL 30	22000030	30	18,90	125	140	107	0,10
MXL 32	22000032	32	20,19	125	140	108	0,12
MXL 34	22000034	34	21,48	125	140	108	0,13
MXL 36	22000036	36	22,78	140	140	109	0,15
MXL 38	22000038	38	24,07	140	140	109	0,17
MXL 40	22000040	40	25,36	140	140	110	0,19
MXL 42	22000042	42	26,66	140	140	110	0,20
MXL 44	22000044	44	27,95	140	140	111	0,23
MXL 45	22000045	45	28,60	140	140	111	0,24
MXL 48	22000048	48	30,54	140	140	111	0,27
MXL 50	22000050	50	31,83	140	140	112	0,30
MXL 60	22000060	60	38,30	160	160	113	0,49
MXL 70	22000070	70	44,77	160	160	211	0,67
MXL 72	22000072	72	46,06	160	160	211	0,72

### XL PASSO 1/5" (5,08 mm)

MATERIALE: ALLUMINIO UNI 9006 - T6

descrizione	codice	Z	de	L1	L	n° flangia adattabile	Kg.
XL 10	23000010	10	15,66	140	140	201	0,07
XL 11	23000011	11	17,28	140	140	201	0,08
XL 12	23000012	12	18,90	140	140	203	0,10
XL 13	23000013	13	20,51	140	140	203	0,11
XL 14	23000014	14	22,13	140	140	204	0,13
XL 15	23000015	15	23,75	140	140	204	0,16
XL 16	23000016	16	25,36	140	140	205	0,18
XL 17	23000017	17	26,98	140	140	205	0,20
XL 18	23000018	18	28,60	140	140	206	0,23
XL 19	23000019	19	30,22	140	140	206	0,26
XL 20	23000020	20	31,83	140	140	207	0,28
XL 21	23000021	21	33,45	160	160	207	0,36
XL 22	23000022	22	35,07	160	160	208	0,40
XL 23	23000023	23	36,60	160	160	208	0,44
XL 24	23000024	24	38,30	160	160	209	0,48
XL 25	23000025	25	39,92	160	160	210	0,51
XL 26	23000026	26	41,53	160	160	210	0,56
XL 27	23000027	27	43,15	160	160	210	0,60
XL 28	23000028	28	44,77	160	160	211	0,65
XL 29	23000029	29	46,39	160	160	211	0,70
XL 30	23000030	30	48,00	160	160	212	0,75
XL 32	23000032	32	51,24	160	160	213	0,87
XL 33	23000033	33	52,85	160	160	213	0,92
XL 34	23000034	34	54,47	160	160	214	0,98
XL 35	23000035	35	56,09	160	160	215	1,04
XL 36	23000036	36	57,70	160	160	216	1,10
XL 38	23000038	38	60,94	160	160	217	1,23
XL 39	23000039	39	62,56	160	160	217	1,30
XL 40	23000040	40	64,17	160	160	217	1,37
XL 41	23000041	41	65,79	160	160	218	1,43
XL 42	23000042	42	67,41	160	160	218	1,51
XL 43	23000043	43	69,02	160	160	313	1,58
XL 44	23000044	44	70,64	160	160	313	1,65
XL 48	23000048	48	77,11	160	160	220	1,98
XL 56	23000056	56	90,04	160	160	223	2,71
XL 60	23000060	60	96,51	160	160	320	3,10
XL 72	23000072	72	115,92	160	160	326	4,52



# BARRE DENTATE PER CINGHIE POSITIVE - ISO 5294

## TIMING BELT BARS - ISO 5294

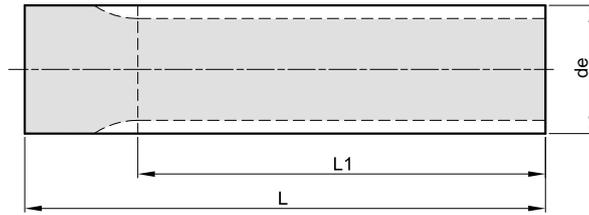

### L PASSO 3/8" (9,525 mm)

MATERIALE: ALLUMINIO UNI 9006 - T6

descrizione	codice	Z	de	L1	L	n° flangia adattabile	Kg.
L 10	24000010	10	29,56	140	140	300	0,23
L 11	24000011	11	32,59	140	140	301	0,28
L 12	24000012	12	35,62	160	160	302	0,39
L 13	24000013	13	38,65	160	160	303	0,46
L 14	24000014	14	41,68	160	160	304	0,55
L 15	24000015	15	44,72	160	160	305	0,63
L 16	24000016	16	47,75	160	160	306	0,73
L 17	24000017	17	50,78	160	160	307	0,82
L 18	24000018	18	53,81	160	160	308	0,93
L 19	24000019	19	56,84	160	160	309	1,04
L 20	24000020	20	59,88	160	160	310	1,16
L 21	24000021	21	62,91	160	160	311	1,28
L 22	24000022	22	65,94	160	160	312	1,41
L 23	24000023	23	68,97	160	160	313	1,55
L 24	24000024	24	72,00	160	160	313	1,69
L 27	24000027	27	81,10	160	160	315	2,15
L 30	24000030	30	90,20	160	160	318	2,67

### L PASSO 3/8" (9,525 mm)

MATERIALE: ACCIAIO

descrizione	codice	Z	de	L1	L	n° flangia adattabile	Kg.
L 10	24100010	10	29,56	140	140	300	0,66
L 11	24100011	11	32,59	140	140	301	0,81
L 12	24100012	12	35,62	160	160	302	1,12
L 13	24100013	13	38,65	160	160	303	1,32
L 14	24100014	14	41,68	160	160	304	1,57
L 15	24100015	15	44,72	160	160	305	1,81
L 16	24100016	16	47,75	160	160	306	2,08
L 17	24100017	17	50,78	160	160	307	2,34
L 18	24100018	18	53,81	160	160	308	2,64
L 19	24100019	19	56,84	160	160	309	2,96
L 20	24100020	20	59,88	160	160	310	3,32
L 21	24100021	21	62,91	160	160	311	3,67
L 22	24100022	22	65,94	160	160	312	4,07
L 23	24100023	23	68,97	160	160	313	4,44
L 24	24100024	24	72,00	160	160	313	4,86
L 27	24100027	27	81,10	160	160	315	6,20
L 30	24100030	30	90,20	160	160	318	7,72



# BARRE DENTATE PER CINGHIE HTD®

## HTD® TIMING BELT BARS

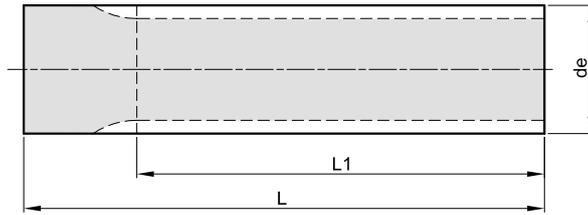

### HTD 5M PASSO 5 mm

MATERIALE: ALLUMINIO UNI 9006 - T6

descrizione	codice	Z	de	L1	L	n° flangia adattabile	Kg.
5M 12	50000012	12	17,96	160	160	202	0,08
5M 13	50000013	13	19,55	160	160	203	0,10
5M 14	50000014	14	21,14	175	200	203	0,16
5M 15	50000015	15	22,73	175	200	204	0,19
5M 16	50000016	16	24,32	175	200	204	0,21
5M 17	50000017	17	25,92	175	200	205	0,24
5M 18	50000018	18	27,51	200	200	205	0,27
5M 19	50000019	19	29,10	200	200	205	0,31
5M 20	50000020	20	30,69	200	200	206	0,35
5M 21	50000021	21	32,28	200	200	207	0,39
5M 22	50000022	22	33,87	200	200	207	0,43
5M 23	50000023	23	35,47	200	200	208	0,48
5M 24	50000024	24	37,06	200	200	208	0,52
5M 25	50000025	25	38,65	200	200	209	0,57
5M 26	50000026	26	40,24	200	200	209	0,62
5M 27	50000027	27	41,83	200	200	210	0,67
5M 28	50000028	28	43,42	200	200	210	0,73
5M 30	50000030	30	46,61	200	200	211	0,84
5M 32	50000032	32	49,79	200	200	212	0,97
5M 34	50000034	34	52,97	200	200	213	1,11
5M 36	50000036	36	56,16	200	200	214	1,25
5M 38	50000038	38	59,34	200	200	216	1,40
5M 40	50000040	40	62,52	200	200	217	1,55
5M 42	50000042	42	65,71	200	200	218	1,73
5M 44	50000044	44	68,89	200	200	218	1,90
5M 45	50000045	45	70,48	200	200	313	1,99
5M 48	50000048	48	75,25	200	200	219	2,27
5M 50	50000050	50	78,44	200	200	220	2,48
5M 60	50000060	60	94,35	200	200	320	3,60
5M 72	50000072	72	113,45	200	200	225	5,28

### HTD 8M PASSO 8 mm

MATERIALE: ACCIAIO

descrizione	codice	Z	de	L1	L	n° flangia adattabile	Kg.
8M 18	51000018	18	44,47	200	200	304	2,03
8M 19	51000019	19	47,01	200	200	305	2,30
8M 20	51000020	20	49,56	200	200	306	2,57
8M 21	51000021	21	52,11	200	200	307	2,88
8M 22	51000022	22	54,65	200	200	308	3,18
8M 23	51000023	23	57,20	200	200	309	3,52
8M 24	51000024	24	59,75	200	200	310	3,86
8M 25	51000025	25	62,29	200	200	310	4,23
8M 26	51000026	26	64,84	200	200	311	4,60
8M 28	51000028	28	69,93	200	200	312	5,40
8M 30	51000030	30	75,02	200	200	314	6,27
8M 32	51000032	32	80,12	200	200	315	7,20
8M 34	51000034	34	85,21	200	200	316	8,20
8M 35	51000035	35	87,76	200	200	317	8,71
8M 36	51000036	36	90,30	200	200	319	9,26
8M 38	51000038	38	95,40	200	200	320	10,39
8M 40	51000040	40	100,49	200	200	321	11,58
8M 44	51000044	44	110,68	200	200	325	14,16
8M 48	51000048	48	120,86	200	200	327	16,99



# BARRE DENTATE "PCB" PER CINGHIE SYNCHROCHAIN "PCB" TIMING BELTS BARS

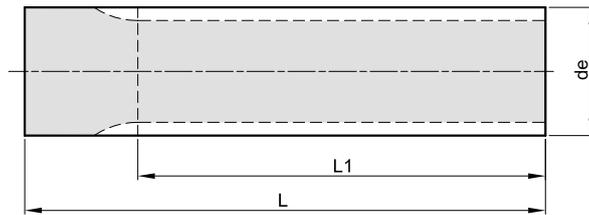

## PCB 8M PASSO 8 mm MATERIALE: ACCIAIO

descrizione	codice	Z	de	L1	L	n° flangia adattabile	Kg.
* 8M 22	PCB51000022	22	54,42	180	180	308	3,20
* 8M 25	PCB51000025	25	62,06	180	180	310	4,20
* 8M 28	PCB51000028	28	69,70	180	180	312	5,20
* 8M 30	PCB51000030	30	74,79	180	180	314	6,00
* 8M 32	PCB51000032	32	79,89	180	180	315	6,90
* 8M 34	PCB51000034	34	84,98	180	180	316	7,80
* 8M 36	PCB51000036	36	90,07	180	180	319	8,90
* 8M 38	PCB51000038	38	95,17	180	180	320	10,00
* 8M 40	PCB51000040	40	100,26	200	200	321	12,30
* 8M 45	PCB51000045	45	112,99	200	200	325	15,40
* 8M 48	PCB51000048	48	120,63	200	200	327	17,70
* 8M 50	PCB51000050	50	125,72	200	200	328	18,20
* 8M 56	PCB51000056	56	141,00	200	200	333	24,50
* 8M 60	PCB51000060	60	151,19	200	200	335	28,10
* 8M 64	PCB51000064	64	161,37	200	200	338	31,80
* 8M 75	PCB51000075	75	189,39	200	200	342	44,00

## PCB 14M PASSO 14 mm MATERIALE: ACCIAIO

descrizione	codice	Z	de	L1	L	n° flangia adattabile	Kg.
* 14M 28	PCB52000028	28	121,98	200	200	400	18,00
* 14M 30	PCB52000030	30	130,89	200	200	401	20,80
* 14M 32	PCB52000032	32	139,80	200	200	403	23,80
* 14M 34	PCB52000034	34	148,72	200	200	404	27,00
* 14M 36	PCB52000036	36	157,63	200	200	405	30,30
* 14M 38	PCB52000038	38	166,54	200	200	406	33,90
* 14M 40	PCB52000040	40	175,45	200	200	407	37,70
* 14M 44	PCB52000044	44	193,28	200	200	411	45,90
* 14M 48	PCB52000048	48	211,11	200	200	412	54,80



# BARRE DENTATE PASSO METRICO SERIE "T" - DIN 7721-2

## METRIC BARS "T" - DIN 7721-2

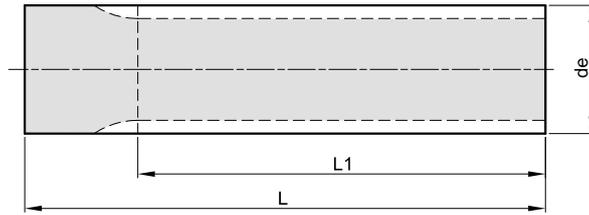

### T 2,5 PASSO 2,5 mm

MATERIALE: ALLUMINIO UNI 9006 - T6

descrizione	codice	Z	de	L1	L	n° flangia adattabile	Kg.
T 2,5 10	34000010	10	7,42	50	75		0,01
T 2,5 12	34000012	12	9,00	50	75	100	0,01
T 2,5 13	34000013	13	9,80	50	75	100	0,02
T 2,5 14	34000014	14	10,60	50	75	101	0,02
T 2,5 15	34000015	15	11,40	75	75	101	0,02
T 2,5 16	34000016	16	12,20	75	75	102	0,02
T 2,5 17	34000017	17	13,00	75	75	104	0,03
T 2,5 18	34000018	18	13,80	75	75	104	0,03
T 2,5 19	34000019	19	14,60	120	120	104	0,05
T 2,5 20	34000020	20	15,40	120	120	105	0,05
T 2,5 21	34000021	21	16,20	120	120	105	0,06
T 2,5 22	34000022	22	17,00	140	140	106	0,08
T 2,5 24	34000024	24	18,55	140	140	107	0,09
T 2,5 26	34000026	26	20,15	140	140	108	0,12
T 2,5 27	34000027	27	20,95	140	140	108	0,13
T 2,5 28	34000028	28	21,75	140	140	108	0,14
T 2,5 29	34000029	29	22,55	140	140	109	0,15
T 2,5 30	34000030	30	23,35	140	140	109	0,15
T 2,5 32	34000032	32	24,95	140	140	110	0,18
T 2,5 34	34000034	34	26,55	140	140	110	0,21
T 2,5 35	34000035	35	27,35	140	140	110	0,21
T 2,5 36	34000036	36	28,10	140	140	111	0,22
T 2,5 38	34000038	38	29,70	140	140	111	0,26
T 2,5 40	34000040	40	31,30	140	140	112	0,27
T 2,5 42	34000042	42	32,90	140	140	112	0,32
T 2,5 44	34000044	44	34,50	140	140	113	0,33
T 2,5 45	34000045	45	35,30	140	140	113	0,37
T 2,5 48	34000048	48	37,70	140	140	208	0,40
T 2,5 50	34000050	50	39,29	160	160	209	0,52
T 2,5 60	34000060	60	47,25	160	160	211	0,72
T 2,5 65	34000065	65	51,20	160	160	213	0,87
T 2,5 70	34000070	70	55,20	160	160	215	1,05
T 2,5 72	34000072	72	56,80	160	160	215	1,11
T 2,5 90	34000090	90	71,12	160	160	219	1,75
T 2,5 100	34000100	100	79,08	160	160	220	2,18





# BARRE DENTATE PASSO METRICO SERIE "T" - DIN 7721-2

## METRIC BARS "T" - DIN 7721-2

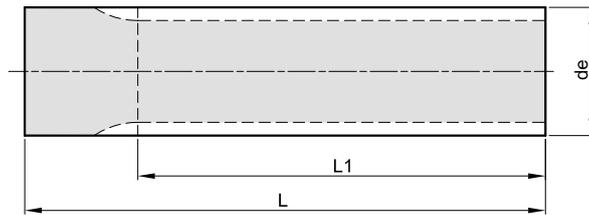

### T 5 PASSO 5 mm

MATERIALE: ALLUMINIO UNI 9006 - T6

descrizione	codice	Z	de	L1	L	n° flangia adattabile	Kg.
T 5 10	35000010	10	15,05	140	140	200	0,06
T 5 11	35000011	11	16,65	140	140	201	0,07
T 5 12	35000012	12	18,25	140	140	201	0,09
T 5 13	35000013	13	19,85	140	140	203	0,10
T 5 14	35000014	14	21,45	140	140	203	0,12
T 5 15	35000015	15	23,05	140	140	204	0,14
T 5 16	35000016	16	24,60	140	140	205	0,16
T 5 17	35000017	17	26,20	140	140	205	0,19
T 5 18	35000018	18	27,80	140	140	205	0,21
T 5 19	35000019	19	29,40	140	140	206	0,24
T 5 20	35000020	20	31,00	160	160	206	0,31
T 5 21	35000021	21	32,70	160	160	207	0,33
T 5 22	35000022	22	34,25	160	160	207	0,36
T 5 23	35000023	23	35,85	160	160	208	0,39
T 5 24	35000024	24	37,40	160	160	208	0,43
T 5 25	35000025	25	38,95	160	160	209	0,47
T 5 26	35000026	26	40,60	160	160	209	0,51
T 5 27	35000027	27	42,20	160	160	210	0,55
T 5 28	35000028	28	43,75	160	160	210	0,60
T 5 29	35000029	29	45,35	160	160	211	0,65
T 5 30	35000030	30	46,95	160	160	211	0,70
T 5 32	35000032	32	50,10	160	160	212	0,80
T 5 34	35000034	34	53,25	160	160	213	0,91
T 5 35	35000035	35	54,85	160	160	214	0,98
T 5 36	35000036	36	56,45	160	160	215	1,02
T 5 37	35000037	37	58,06	160	160	215	1,08
T 5 38	35000038	38	59,65	160	160	216	1,14
T 5 40	35000040	40	62,85	160	160	216	1,27
T 5 42	35000042	42	66,00	160	160	217	1,41
T 5 44	35000044	44	69,20	160	160	218	1,55
T 5 45	35000045	45	70,80	160	160	313	1,63
T 5 46	35000046	46	72,40	160	160	313	1,69
T 5 48	35000048	48	75,55	160	160	219	1,85
T 5 50	35000050	50	78,75	160	160	220	2,02
T 5 60	35000060	60	94,65	160	160	320	2,95
T 5 72	35000072	72	113,75	160	160	225	4,28
T 5 80	35000080	80	126,48	160	160	226	5,39
T 5 90	35000090	90	142,40	160	160	333	6,76
T 5 100	35000100	100	158,31	160	160	338	8,34

### T 10 PASSO 10 mm

MATERIALE: ALLUMINIO UNI 9006 - T6

descrizione	codice	Z	de	L1	L	n° flangia adattabile	Kg.
T 10 10	36000010	10	29,98	140	140	206	0,22
T 10 11	36000011	11	33,16	140	140	207	0,29
T 10 12	36000012	12	36,35	140	140	208	0,34
T 10 13	36000013	13	39,55	140	140	209	0,42
T 10 14	36000014	14	42,70	160	160	210	0,55
T 10 15	36000015	15	45,90	160	160	211	0,64
T 10 16	36000016	16	49,10	160	160	212	0,74
T 10 17	36000017	17	52,25	160	160	213	0,85
T 10 18	36000018	18	55,45	160	160	214	0,96
T 10 19	36000019	19	58,65	160	160	216	1,07
T 10 20	36000020	20	61,80	160	160	216	1,20
T 10 21	36000021	21	65,00	160	160	217	1,29
T 10 22	36000022	22	68,20	160	160	218	1,43
T 10 23	36000023	23	71,35	160	160	313	1,58
T 10 24	36000024	24	74,55	160	160	219	1,73
T 10 26	36000026	26	80,90	160	160	220	2,05
T 10 28	36000028	28	87,25	160	160	222	2,39
T 10 30	36000030	30	93,65	160	160	223	2,76
T 10 32	36000032	32	100,00	160	160	224	3,18
T 10 34	36000034	34	106,40	160	160	323	3,61
T 10 36	36000036	36	112,75	160	160	225	4,06
T 10 38	36000038	38	119,10	160	160	327	4,62
T 10 40	36000040	40	125,45	160	160	226	5,13
T 10 45	36000045	45	141,40	160	160	333	6,50
T 10 48	36000048	48	150,95	160	160	335	7,39
T 10 60	36000060	60	189,15	160	160	342	11,76
T 10 72	36000072	72	227,29	160	160		17,03



# BARRE DENTATE PASSO METRICO SERIE BAT PER CINGHIE "AT" METRIC BARS "AT"

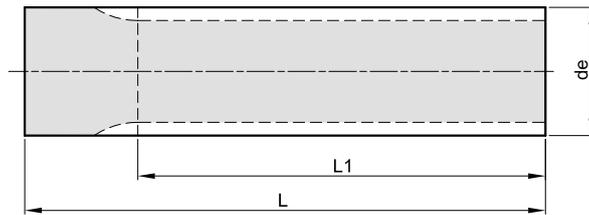

## BAT 5 PASSO 5 mm

MATERIALE: ALLUMINIO UNI 9006 - T6

descrizione	codice	Z	de	L1	L	n° flangia adattabile	Kg.
BAT 5 12	68000012	12	17,85	140	140	201	0,08
BAT 5 13	68000013	13	19,45	140	140	203	0,10
BAT 5 14	68000014	14	21,05	140	140	203	0,12
BAT 5 15	68000015	15	22,65	140	140	204	0,14
BAT 5 16	68000016	16	24,20	140	140	205	0,15
BAT 5 17	68000017	17	25,80	140	140	205	0,18
BAT 5 18	68000018	18	27,40	140	140	205	0,20
BAT 5 19	68000019	19	29,00	140	140	206	0,23
BAT 5 20	68000020	20	30,60	160	160	206	0,30
BAT 5 21	68000021	21	32,30	160	160	207	0,33
BAT 5 22	68000022	22	33,85	160	160	207	0,36
BAT 5 23	68000023	23	35,45	160	160	208	0,40
BAT 5 24	68000024	24	37,00	160	160	208	0,44
BAT 5 25	68000025	25	38,55	160	160	209	0,47
BAT 5 26	68000026	26	40,20	160	160	209	0,51
BAT 5 27	68000027	27	41,80	160	160	210	0,55
BAT 5 28	68000028	28	43,35	160	160	210	0,60
BAT 5 30	68000030	30	46,55	160	160	211	0,69
BAT 5 32	68000032	32	49,70	160	160	212	0,81
BAT 5 34	68000034	34	52,85	160	160	213	0,90
BAT 5 36	68000036	36	56,05	160	160	215	1,02
BAT 5 38	68000038	38	59,25	160	160	216	1,14
BAT 5 40	68000040	40	62,45	160	160	216	1,28
BAT 5 42	68000042	42	65,60	160	160	217	1,41
BAT 5 44	68000044	44	68,80	160	160	218	1,55
BAT 5 46	68000046	46	72,00	160	160	313	1,70
BAT 5 48	68000048	48	75,15	160	160	219	1,85
BAT 5 52	68000052	52	81,55	160	160	220	2,19
BAT 5 56	68000056	56	87,90	160	160	222	2,55
BAT 5 58	68000058	58	91,10	160	160	223	2,74
BAT 5 60	68000060	60	94,25	160	160	320	2,94
BAT 5 64	68000064	64	100,65	160	160	224	3,36
BAT 5 72	68000072	72	113,35	160	160	225	4,29

## BAT 10 PASSO 10 mm

MATERIALE: ALLUMINIO UNI 9006 - T6

descrizione	codice	Z	de	L1	L	n° flangia adattabile	Kg.
BAT 10 15	69000015	15	45,90	160	160	211	0,62
BAT 10 16	69000016	16	49,10	160	160	212	0,72
BAT 10 17	69000017	17	52,25	160	160	213	0,82
BAT 10 18	69000018	18	55,45	160	160	214	0,94
BAT 10 19	69000019	19	58,65	160	160	216	1,05
BAT 10 20	69000020	20	61,80	160	160	216	1,17
BAT 10 21	69000021	21	65,00	160	160	217	1,31
BAT 10 22	69000022	22	68,20	160	160	218	1,44
BAT 10 23	69000023	23	71,35	160	160	313	1,60
BAT 10 24	69000024	24	74,55	160	160	219	1,75
BAT 10 25	69000025	25	77,75	160	160	219	1,91
BAT 10 26	69000026	26	80,90	160	160	220	2,06
BAT 10 27	69000027	27	84,05	160	160	221	2,23
BAT 10 28	69000028	28	87,25	160	160	222	2,42
BAT 10 30	69000030	30	93,65	160	160	223	2,79
BAT 10 32	69000032	32	100,00	160	160	224	3,20
BAT 10 34	69000034	34	106,40	160	160	323	3,65
BAT 10 36	69000036	36	112,75	160	160	225	4,09
BAT 10 38	69000038	38	119,10	160	160	327	4,59
BAT 10 40	69000040	40	125,45	160	160	226	5,16
BAT 10 42	69000042	42	131,85	160	160	330	5,65
BAT 10 44	69000044	44	138,20	160	160	331	6,22
BAT 10 46	69000046	46	144,55	160	160	334	6,84
BAT 10 48	69000048	48	150,95	160	160	335	7,45
BAT 10 52	69000052	52	163,65	160	160	338	8,93
BAT 10 56	69000056	56	176,40	160	160	339	10,39
BAT 10 58	69000058	58	182,75	160	160	340	10,96
BAT 10 60	69000060	60	189,15	160	160	342	11,78
BAT 10 70	69000070	70	220,95	160	160		16,18



# DIMENSIONI FLANGE PER PULEGGE DENTATE - ZINCATE

## PULLEYS FLANGES DIMENSIONS ZINC PLATED

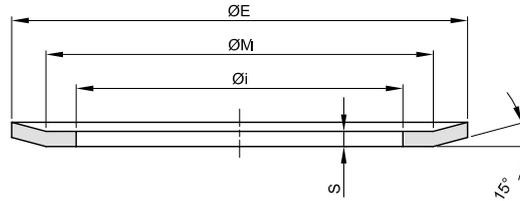

n° flangia	codice	spessore S = 0,5 mm		
		Ø E	Ø M	Ø i
100	5030000100	13	10	6
101	5030000101	15	12	8
102	5030000102	16	13	9,5
104	5030000104	18	15	11,5
105	5030000105	19,5	17,5	12
106	5030000106	23	17,5	12
107	5030000107	23	20	14
108	5030000108	25	22	15
109	5030000109	28	24	18
110	5030000110	32	28	21,5
111	5030000111	36	31	25
112	5030000112	38	34	28
113	5030000113	42	38	30,5
114	5030000114	48	43,5	37

n° flangia	codice	spessore S = 1 mm		
		Ø E	Ø M	Ø i
200	5030000200	19,5	17,5	12
201	5030000201	23	17,5	12
202	5030000202	23	20	14
203	5030000203	25	22	15
204	5030000204	28	24	18
205	5030000205	32	28	21,5
206	5030000206	36	31	25
207	5030000207	38	34	28
208	5030000208	42	38	30,5
209	5030000209	44	40	33
210	5030000210	48	43,5	37
211	5030000211	51	47,5	40
212	5030000212	54	50,5	43
213	5030000213	57	53	46
214	5030000214	60	57	47
215	5030000215	63	57	48
216	5030000216	66	61,5	52
217	5030000217	71	65	56
218	5030000218	75	68,5	60
219	5030000219	83	76,5	68
220	5030000220	87	82,5	72
221	5030000221	91	85,5	76
222	5030000222	93	89	80
223	5030000223	97	93	83
224	5030000224	106	101	90
225	5030000225	119	113,5	103
226	5030000226	131	125,5	115



# DIMENSIONI FLANGE PER PULEGGE DENTATE - ZINCATE

## PULLEYS FLANGES DIMENSIONS ZINC PLATED

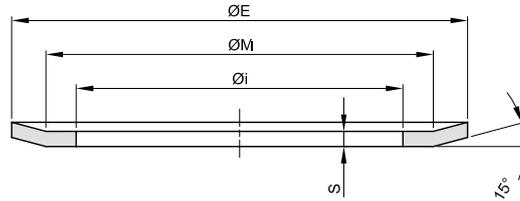

n° flangia	codice	spessore S = 1,5 mm		
		Ø E	Ø M	Ø i
300	5030000300	36	31	25
301	5030000301	38	34	28
302	5030000302	42	38	30,5
303	5030000303	44	40	33
304	5030000304	48	43,5	37
305	5030000305	51	47,5	40
306	5030000306	54	50,5	43
307	5030000307	57	53	46
308	5030000308	60	57	47
309	5030000309	63	57	48
310	5030000310	66	61,5	52
311	5030000311	71	65	56
312	5030000312	75	68,5	60
313	5030000313	79	73,5	64
314	5030000314	83	76,5	68
315	5030000315	87	82,5	72
316	5030000316	91	85,5	76
317	5030000317	93	89	80
318	5030000318	97	93	83
319	5030000319	98	92	79,3
320	5030000320	103	97	86
321	5030000321	106	101	90
322	5030000322	111	106	94
323	5030000323	115	110	99
325	5030000325	119	113,5	103
326	5030000326	123	117,5	107
327	5030000327	127	122	111
328	5030000328	135	130	119
330	5030000330	140	134,5	123
331	5030000331	143	139	127
333	5030000333	148	143	132
334	5030000334	152	147,5	136
335	5030000335	158	154	142
338	5030000338	168	163	149,5
339	5030000339	184	179	165
340	5030000340	192	187	173
342	5030000342	200	195	181

n° flangia	codice	spessore S = 2,5 mm		
		Ø E	Ø M	Ø i
400	5030000400	127	120,2	104,7
401	5030000401	138	130	108
402	5030000402	146	138	116
403	5030000403	154	146	122
404	5030000404	160	150	128
405	5030000405	168	162	135
406	5030000406	183	170	145
407	5030000407	188	180	158
409	5030000409	198	188	165
410	5030000410	200	192,8	172
411	5030000411	211	198	173
412	5030000412	226	214	190
414	5030000414	240	224	192
415	5030000415	256	240	220
416	5030000416	256	247	225
418	5030000418	296	287	252



## CODICE NUMERICO FLANGE PER PULEGGE DENTATE CODES OF FLANGES FOR TIMING PULLEYS

n° denti puleggia	MXL SP. 0,5	XL SP. 1	L SP. 1,5	H SP. 1,5	XH SP. 2,5	HTD 3M SP. 0,5	HTD 5M SP. 1	HTD 8M SP. 1,5	HTD 14M SP. 2,5	PCB 8M SP. 1,5	PCB 14M SP. 2,5	T 2,5 SP. 0,5	T 5 SP. 1	T 10 SP. 1	BAT 5 SP. 1	BAT 10 SP. 1
10		201	300			100							200	206		
11		201	301										201	207		
12	100	203	302			101	202					100	201	208	201	208
13		203	303				203					100	203	209	203	
14	100	204	304	309		102	203					101	203	210	203	210
15	100	204	305	310		104	204					101	204	211	204	211
16	101	205	306	311		104	204					102	205	212	205	212
17		205	307	312			205					104	205	213	205	213
18	102	206	308	313	401	105	205	304				104	205	214	205	214
19		206	309	314	402		205	305				104	206	216	206	216
20	102	207	310	315	403	107	206	306				105	206	216	206	216
21		207	311	316	404	108	207	307				105	207	217	207	217
22	104	208	312	317	405	108	207	308		308		106	207	218	207	218
23		208	313	318			208	309					208	313	208	313
24	104	209	313	320	406	108	208	310				107	208	219	208	219
25	105	210	314	321	407		209	310		310		107	209	219	209	219
26	106	210	315	322	409	109	209	311				108	209	220	209	220
27		210	315	323	410		210					108	210	221	210	221
28	107	211	316	325	411	110	210	312	400	312	400	108	210	222	210	222
29		211		326								109	211			
30	107	212	318	327	412	110	211	314	401	314	401	109	211	223	211	223
32	108	213	320	328	414	111	212	315	403	315	403	110	212	224	212	224
33		213	321	330												
34	108	214	322	331	415		213	316	404	316	404	110	213	323	213	323
35		215	322	333				317				110	214			
36	109	216	323	334		112	214	319	405		405	111	215	225	215	225
37													215			
38	109	217		335			216	320	406	320	406	111	216	327	216	327
39		217														
40	110	217	327	338		113	217	321	407	321	407	112	216	226	216	226
41		218														
42	110	218	328				218					112	217		217	330
43		313														
44	111	313	330	339		114	218	325	411		411	113	218		218	331
45	111		331	340			313			325		113	313	333		
46													313		313	334
48	111	220	334	342			219	327	412	327	412	208	219	335	219	335
50	112						220			328	414	209	220			
52															220	338
56		223					222	333	416	333	416				222	339
58															223	340
60	113	320					320			335		211	320	342	320	342
64							224	338	418	338						224
65												213				
70	211											215			224	
72	211	326					225	340				215	225		225	
75										342						
80													226			
90												219	333			
100												220	338			





## PIASTRE DI BLOCCAGGIO PER CINGHIE DENTATE CLAMPING BELT PLATES

Le piastre di bloccaggio per cinghie sono utilizzate per fissare le estremità della cinghia qualora si voglia ottenere, dal moto rotatorio delle pulegge, un moto rettilineo alternato per tavole o altri dispositivi.

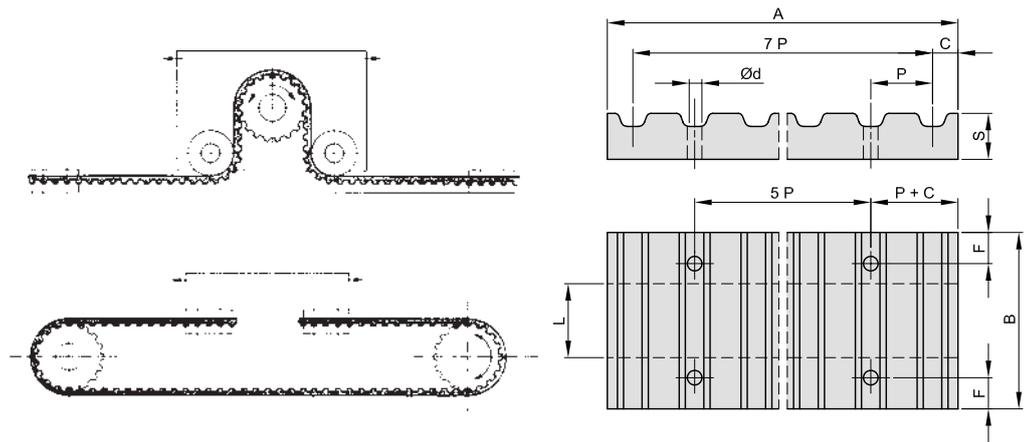

Materiale: Alluminio

descrizione	codice	passo	A	B	Ø d	F	C	S	L	Kg.
<b>XL 025</b>	5010013025	5,08	42,5	25,5	5,5	6	3,5	8	6,4	0,02
<b>XL 037</b>	5010013037	5,08	42,5	28,5	5,5	6	3,5	8	9,5	0,02
<b>L 050</b>	5010014050	9,525	76,6	39	9	8	5	15	12,7	0,10
<b>L 075</b>	5010014075	9,525	76,6	45	9	8	5	15	19,1	0,12
<b>L 100</b>	5010014100	9,525	76,6	51,5	9	8	5	15	25,4	0,14
<b>H 050</b>	5010015050	12,70	106,9	45	11	10	9	22	12,7	0,25
<b>H 075</b>	5010015075	12,70	106,9	51	11	10	9	22	19,1	0,28
<b>H 100</b>	5010015100	12,70	106,9	57,5	11	10	9	22	25,4	0,32
<b>5M 9</b>	5010041009	5	41,5	28	5,5	6	3,2	8	9	0,02
<b>5M 15</b>	5010041015	5	41,5	34	5,5	6	3,2	8	15	0,03
<b>5M 25</b>	5010041025	5	41,5	44	5,5	6	3,2	8	25	0,04
<b>8M 20</b>	5010042020	8	66	45	9	8	5	15	20	0,10
<b>8M 30</b>	5010042030	8	66	55	9	8	5	15	30	0,12
<b>8M 50</b>	5010042050	8	66	75	9	8	5	15	50	0,17
<b>8M 85</b>	5010042085	8	66	110	9	8	5	15	85	0,25
<b>14M 40</b>	5010043040	14	116	71	11	10	9	22	40	0,40
<b>14M 55</b>	5010043055	14	116	86	11	10	9	22	55	0,50
<b>14M 85</b>	5010043085	14	116	116	11	10	9	22	85	0,68
<b>14M 115</b>	5010043115	14	116	146	11	10	9	22	115	0,85
<b>14M 170</b>	5010043170	14	116	201	11	10	9	22	170	1,14
<b>T 5 10</b>	5010027010	5	41,8	29	5,5	6	3,4	8	10	0,02
<b>T 5 16</b>	5010027016	5	41,8	35	5,5	6	3,4	8	16	0,03
<b>T 5 25</b>	5010027025	5	41,8	44	5,5	6	3,4	8	25	0,04
<b>T10 16</b>	5010028016	10	80	41	9	8	5	15	16	0,11
<b>T10 25</b>	5010028025	10	80	50	9	8	5	15	25	0,14
<b>T10 32</b>	5010028032	10	80	57	9	8	5	15	32	0,16
<b>T10 50</b>	5010028050	10	80	75	9	8	5	15	50	0,22
<b>AT5 10</b>	5010060010	5	41,8	29	5,5	6	3,4	8	10	0,02
<b>AT5 16</b>	5010060016	5	41,8	35	5,5	6	3,4	8	16	0,03
<b>AT5 25</b>	5010060025	5	41,8	44	5,5	6	3,4	8	25	0,04
<b>AT10 16</b>	5010061016	10	80	41	9	8	5	15	16	0,11
<b>AT10 25</b>	5010061025	10	80	50	9	8	5	15	25	0,14
<b>AT10 32</b>	5010061032	10	80	57	9	8	5	15	32	0,16
<b>AT10 50</b>	5010061050	10	80	75	9	8	5	15	50	0,22

