



## SKF Transmission chain



© SKF is a registered trademark of the SKF Group.

© SKF Group 2008

The contents of this publication are the copyright of the publisher and may not be reproduced (even extracts) unless permission is granted. Every care has been taken to ensure the accuracy of the information contained in this publication but no liability can be accepted for any loss or damage whether direct, indirect or consequential arising out of the use of the information contained herein.

Publication **6772 EN** · July 2008

Printed in Germany on environmentally friendly paper.

# Standard and compliance

SKF Chains are manufactured in state of the art facilities. Tight quality controls are employed to assure product conformance to the ISO standards and the existing industrial standards mainly ANSI, BS, DIN and JIS. SKF Oil field chains are American Petroleum Institute (API) approved and each box carries the API monogram. SKF automotive chain meets the ISO/TS16949 Quality Assurance System technical specification. This specification aligns american (QS-9000), german (VDA6.1), french (EAQF) and the italian (AVSQ) automotive quality system standards within the global automotive industry.

All SKF Chains have a normal operating temperature range of -20 to 150 °C. An exception are stainless steel chains with a range of -20 to 400 °C. For higher temperatures alternative lubrication should be applied. Please, also note that for temperatures over 200 °C and below -20 °C breaking load values are reduced.



## Raw material

The basic materials to make each component of the chain are critical hence strict controls of all incoming materials are implemented even before the production begins. These controls range from careful steel mills selection to constant auditing of the suppliers. Each batch of raw material received arrives with a laboratory report certifying the material composition. Samples are taken from incoming stock to be thoroughly analyzed to ensure that the chemical composition meets the factory's strict material specifications.

After stringent inspections, the materials will go through various pre-production treatments. Firstly, annealing is done in order to bring the materials to the perfect working condition followed by multi stage rolling which ensures the consistency in plate thickness. Various other processes are also carried out depending on individual material and part requirements.



Continuous rolling machine to achieve uniform thickness of plate material

## The process

SKF Chain manufacturing process  
Roller chain – manufacturing process and test operation

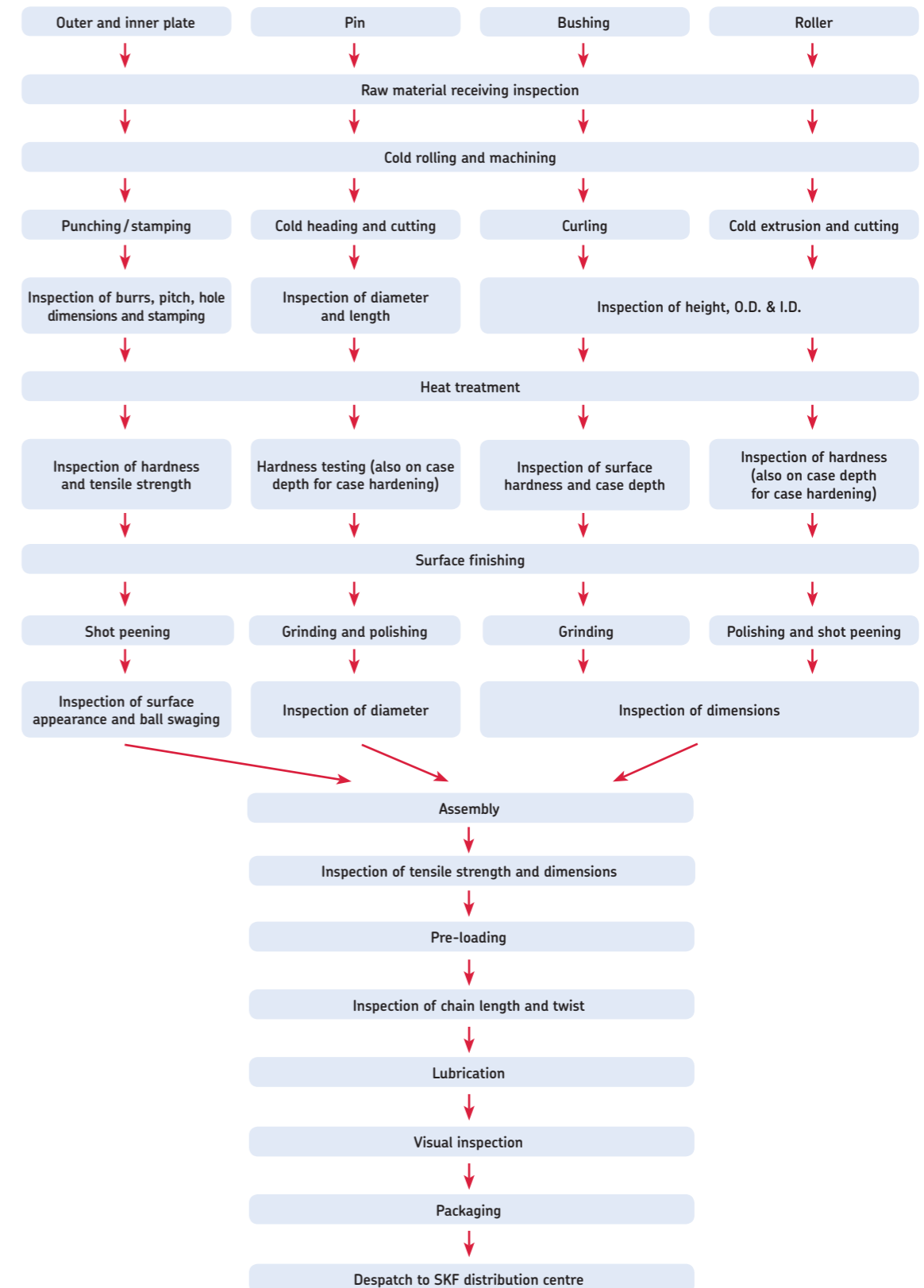

# Chain parts



## Link plates (Inner and outer plates)

SKF Chains have adopted a wider waist link plate contour design, this increases the fatigue strength. By subjecting the raw material through a series of cold rolling processes and stringent thickness controls, the plates achieve uniform thicknesses which are critical to a smooth running chain. The plates endurance and strength is fully optimized via thru-hardening, shot peening and apertures ball-burnishing process.



Shot peening parts improve fatigue and crack resistance



Furnaces for heat treatment process

## Pin

The pin material is manufactured primarily from alloy steel and has a case hardened surface to give the maximum wear tolerance and a high strength tough core for better resistance to impact forces. These are achieved with rotary furnaces to ensure uniform heat dispersion on the pins during heat treatment. The pins are also precision ground to further enhance the wear resistance.



Rotary furnaces are used for pin heat treatment to ensure uniform heat dispersion.

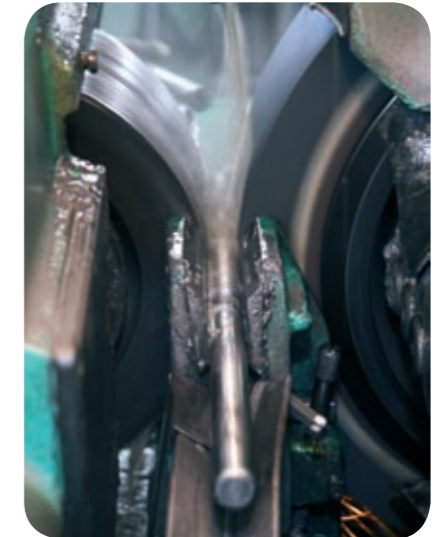

Pins are ground to thoroughly optimize the wear life.

## Bushings

Cold rolling gives an overall uniform wall thickness which is extremely important in achieving a precise and consistent pitch. Precision curling units ensure that the inside and outside roundness of the bushings are controlled, for the optimum bush-link plate fit. The case hardening process gives the bushings high wear endurance with a tough impact resistant core. The bushings are then subjected to precision grinding to achieve long wear life.



Conveyor furnace line used for roller and bushing heat treatment e.g. carbon-nitriding



Automated chain assembly to ensure proper fits and tolerances are met.

## Rollers

SKF Chains use solid rollers that are cold extruded from bar stock, resulting in good fatigue strength and improved shock loading capabilities. All rollers go through a hardening process to ensure an extended wear life. To avoid crack propagation, shot peening is introduced, this also gives the rollers better fatigue strength which provides the required protection.



Parts manufacturing lines



Microhardness testing equipment where batch tests are done to ensure hardness is within specification

## Assembly process

Advanced automation machines ensure that the parts are assembled to the correct tolerances giving SKF Chains a precise spaced pitch with a perfect fit. Every part and process is subject to strict quality controls with frequent checks to ensure conformance to tolerances and standards. Depending on the requirements, various anti-corrosion treatments and special coatings are readily available upon request.

The assembled chains are then pre-stretched. This running in of the chain not only eliminates initial elongation but also increases the chain's fatigue resistance.

The final process of pre-lubrication provides SKF Chains with lubrication that is ready for the chains initial start-up. The pre-lubrication also acts as a corrosion protection for an assured long shelf life.



Pre-lubrication product line



Pre-loading after final assembly

## Connecting links

These links are used to connect two ends of a chain together to form an endless chain. The spring clip and cotter pin types enable easy dismantling and replacement of the chain while the rivet type provides a very strong link with similar fatigue strength to the other links in the chain.

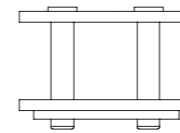
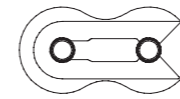

Connecting link (spring clip type)

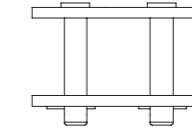
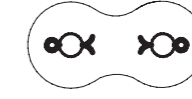

Connecting link (cotter pin type)

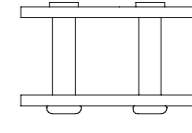
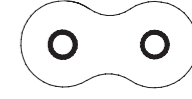

Connecting link (rivetted type)

## Offset links

Offset links are used when an odd number of pitches are required in a chain. These links consist of two cranked plates which are press fitted onto a bush and roller. The wide end is placed over the last link in the chain and a connecting pin is installed and secured with a split pin.

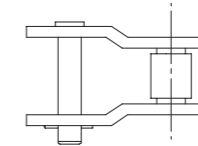
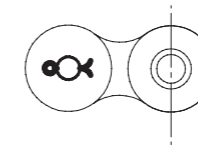

Offset link

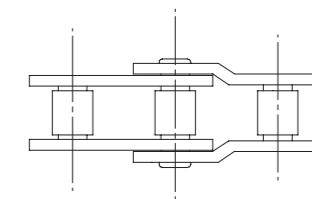
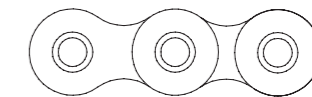

Double offset link



# SKF Xtra Corrosion Resistance Chains

## Stainless steel chains

Stainless steel chains have superior corrosion resistance for the most demanding applications. SKF offers a variety of different stainless steel chains in order to suit the applications where cleanliness is required or harsh chemicals are used. SKF standard stainless steel chains are manufactured in SS304 grade steel for high corrosion resistance and are available in BS and ANSI standards. SS316 and other stainless steel grades are available for higher temperature applications. The SS316 stainless is somewhat more resistant to the effects of magnetic permeability, temperature extremes and harsher chemicals.

### Application

These chains are suitable for food processing, pharmaceutical, high/low temp (-20 to 400 °C) and corrosive environments. Stainless steel chains can be manufactured to withstand temperatures up to 1000 °C with the addition of special lubrication.



Stainless steel chain used in a cheese processing plant



Anti corrosive chains are either made of stainless steel or are covered with a special coating

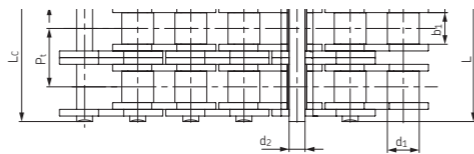
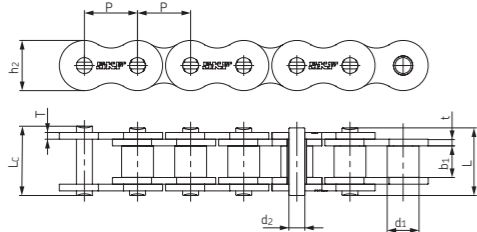

Chain No.	Pitch P	Roller diameter d <sub>1</sub> max	Width between inner plates b <sub>1</sub> max	Pin diameter d <sub>2</sub> max	Pin length L max	Inner plate height L <sub>c</sub> max	Plate thickness t max	Ultimate tensile strength Q min	Weight per meter q	Designation		
25-1SS*	6,350	3,30	3,18	2,31	7,90	8,40	6,00	0,80	0,80	2,5	0,15	PHC 25-1SS...
35-1SS*	9,525	5,08	4,77	3,58	12,40	13,17	9,00	1,30	1,30	5,5	0,33	PHC 35-1SS...
40-1SS	12,700	7,95	7,85	3,96	16,60	17,80	12,00	1,50	1,50	9,6	0,63	PHC 40-1SS...
41-1SS	12,700	7,77	6,25	3,58	13,75	15,00	9,91	1,30	1,30	6,0	0,46	PHC 41-1SS...
50-1SS	15,875	10,16	9,40	5,08	20,70	22,20	15,09	2,03	2,03	15,2	1,03	PHC 50-1SS...
60-1SS	19,050	11,91	12,57	5,94	25,90	27,70	18,00	2,42	2,42	21,7	1,51	PHC 60-1SS...
80-1SS	25,400	15,88	15,75	7,92	32,70	35,00	24,00	3,25	3,25	38,9	2,62	PHC 80-1SS...
100-1SS	31,750	19,05	18,90	9,53	40,40	44,70	30,00	4,00	4,00	60,0	3,94	PHC 100-1SS...
120-1SS	38,100	22,23	25,22	11,10	50,30	54,30	35,70	4,80	4,80	72,5	5,72	PHC 120-1SS...
140-1SS	44,450	25,40	25,22	12,70	54,40	59,00	41,00	5,60	5,60	94,0	7,70	PHC 140-1SS...
04B-1SS	6,000	4,00	2,80	1,85	6,80	7,80	5,00	0,60	0,60	2,0	0,11	PHC 04B-1SS...
05B-1SS	8,000	5,00	3,00	2,31	8,20	8,90	7,10	0,80	0,80	3,5	0,20	PHC 05B-1SS...
06B-1SS^	9,525	6,35	5,72	3,28	13,15	14,10	8,20	1,30	1,30	6,2	0,41	PHC 06B-1SS...
08B-1SS	12,700	8,51	7,75	4,45	16,70	18,20	11,80	1,60	1,60	12,0	0,70	PHC 08B-1SS...
10B-1SS	15,875	10,16	9,65	5,08	19,50	20,90	14,70	1,70	1,70	14,5	0,94	PHC 10B-1SS...
12B-1SS	19,050	12,07	11,68	5,72	22,50	24,20	16,00	1,85	1,85	18,5	1,16	PHC 12B-1SS...
16B-1SS	25,400	15,88	17,02	8,28	36,10	37,40	21,00	4,15	3,10	40,0	2,73	PHC 16B-1SS...
20B-1SS	31,750	19,05	19,56	10,19	41,30	45,00	26,40	4,50	3,50	59,0	3,73	PHC 20B-1SS...
24B-1SS	38,100	25,40	25,40	14,63	53,40	57,80	33,20	6,00	4,80	104,0	7,20	PHC 24B-1SS...
32B-1SS	50,800	29,21	30,99	17,81	66,00	71,00	42,00	7,00	6,00	150,0	10,22	PHC 32B-1SS...

\* Bushing chain: d<sub>2</sub> indicates external diameter of bushing

^ Straight side plates

Standard lengths are 10 ft and 5 m. To complete designation add chain length. For example, a 5 m box of 80-1SS is PHC 80-1SSX5MTR. For links add "C/L" for "connecting" and "O/L" for "offset" to the designation in the table.

## Nickel-plated

Nickel-plated roller chains combine the strength of standard roller chains with the corrosion resistant properties that come from the nickel-plating. Nickel-plating of all components prior to the assembly assures a uniform coverage to produce the maximum effect of the plating process.

### Application

Nickel-plated chains are most commonly used for outdoor applications, or in a mildly corrosive atmosphere and might be used in an application that has limited contact with water.



Nickel-plated chain used in a canning plant

## Zinc-plated

Zinc-plated roller chains provide a very good adherence of the plating to the base metal and combines the strength of standard roller chains with the corrosion resistance that comes from zinc-plating. Zinc-plating of all components prior to assembly assures uniform coverage to produce the maximum effect of the coating process. Zinc-plating is more economical than nickel-plating.

### Application

Zinc-plated chains are most commonly used for outdoor applications and exposure to sea/salt water environments.



Zinc-plated chains are often used in automatic car washes



## Attachments WA-1, WA-2, WK-1, WK-2

ANSI Chain No.	BS/ISO Chain No.	P	G	L	F	W	T	$h_4$	$d_4$	Designation
-	-	mm	mm	mm	mm	mm	mm	mm	mm	-
35-1	06C-1	9,53	17,32	9,53	19,00	28,60	1,30	6,35	2,80	PHC 35-1...
40-1	08A-1	12,70	23,00	12,70	25,40	35,60	1,50	7,90	3,40	PHC 40-1...
41-1	085-1	12,70	22,30	12,70	24,00	35,00	1,30	7,20	4,85	PHC 41-1...
50-1	10A-1	15,88	28,80	15,88	31,75	46,80	2,03	10,30	5,50	PHC 50-1...
60-1	12A-1	19,05	34,65	19,05	38,10	56,40	2,42	11,90	5,50	PHC 60-1...
80-1	16A-1	25,40	45,90	25,40	50,80	73,20	3,25	15,90	6,80	PHC 80-1...
100-1	20A-1	31,75	57,65	31,75	63,50	89,80	4,00	19,80	9,20	PHC 100-1...
120-1	24A-1	38,10	69,30	38,10	76,20	108,80	4,80	23,00	9,80	PHC 120-1...
140-1	28A-1	44,45	80,45	44,45	88,90	123,00	5,60	28,60	11,40	PHC 140-1...
160-1	32A-1	50,80	92,00	50,80	101,60	142,80	6,40	31,75	13,10	PHC 160-1...
200-1	40A-1	63,50	115,50	63,50	127,00	179,00	8,00	42,88	16,30	PHC 200-1...
-	08B-1	12,70	24,00	12,70	25,40	36,40	1,60	8,90	4,30	PHC 08B-1...
-	10B-1	15,88	29,58	15,88	31,80	44,60	1,70	10,31	5,30	PHC 10B-1...
-	12B-1	19,05	34,05	19,05	38,10	52,00	1,85	13,46	6,40	PHC 12B-1...
-	16B-1	25,40	46,40	25,40	50,80	72,60	3,10	15,88	6,40	PHC 16B-1...
-	20B-1	31,75	58,10	31,75	63,00	100,50	3,50	19,80	9,00	PHC 20B-1...
-	24B-1	38,10	71,30	38,10	76,20	108,40	4,80	26,67	10,50	PHC 24B-1...
-	28B-1	44,45	81,10	44,45	88,90	123,00	6,00	28,58	13,10	PHC 28B-1...
-	32B-1	50,80	92,80	50,80	101,60	142,80	6,00	31,75	13,10	PHC 32B-1...

To complete designation add attachment spacing and type followed by chain length.  
 For example: PHC 80-1-L2WA2X10FT (ANSI 80-1 with WA-2 attachment on every second link, 10 ft length)  
 Note: Also available in stainless steel. When ordering suffix with SS, for example: PHC 80-1SS-L2WA2X10FT

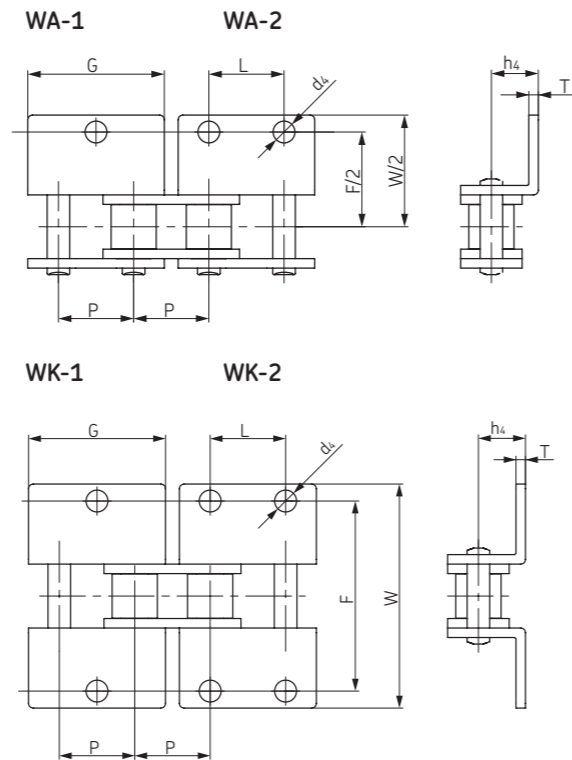

## Attachments WSA-1, WSA-2, WSK-1, WSK-2

ANSI Chain No.	BS/ISO Chain No.	P	G	L	C	F	T	$d_4$	Designation
-	-	mm	mm	mm	mm	mm	mm	mm	-
35-1	06C-1	9,53	17,32	9,53	9,50	14,55	1,30	2,80	PHC 35-1...
40-1	08A-1	12,70	23,00	12,70	12,70	17,40	1,50	3,40	PHC 40-1...
41-1	085-1	12,70	21,20	12,70	11,85	16,55	1,30	3,60	PHC 41-1...
50-1	10A-1	15,88	28,80	15,88	15,90	23,05	2,03	5,50	PHC 50-1...
60-1	12A-1	19,05	34,65	19,05	18,30	26,86	2,42	5,50	PHC 60-1...
80-1	16A-1	25,40	45,90	25,40	24,60	35,45	3,25	6,80	PHC 80-1...
100-1	20A-1	31,75	57,65	31,75	31,80	44,00	4,00	9,20	PHC 100-1...
120-1	24A-1	38,10	69,30	38,10	36,50	51,60	4,80	9,80	PHC 120-1...
140-1	28A-1	44,45	80,45	44,45	44,50	62,00	5,60	11,40	PHC 140-1...
160-1	32A-1	50,80	92,00	50,80	50,80	69,85	6,40	13,10	PHC 160-1...
200-1	40A-1	63,50	115,50	63,50	63,50	88,90	8,00	16,30	PHC 200-1...
-	08B-1	12,70	23,30	12,70	13,35	18,90	1,60	4,30	PHC 08B-1...
-	10B-1	15,88	29,58	15,88	16,50	22,95	1,70	5,30	PHC 10B-1...
-	12B-1	19,05	34,05	19,05	21,45	28,60	1,85	6,40	PHC 12B-1...
-	16B-1	25,40	46,40	25,40	23,15	34,00	3,10	6,40	PHC 16B-1...
-	20B-1	31,75	58,10	31,75	30,50	45,70	3,50	9,00	PHC 20B-1...

To complete designation add attachment spacing and type followed by chain length.  
 For example: PHC 80-1-L4WSA1X10FT (ANSI 80-1 with WSA-1 attachment on every fourth link, 10 ft length)  
 Note: Also available in stainless steel. When ordering suffix with SS, for example: PHC 80-1SS-L4WSA1X10FT

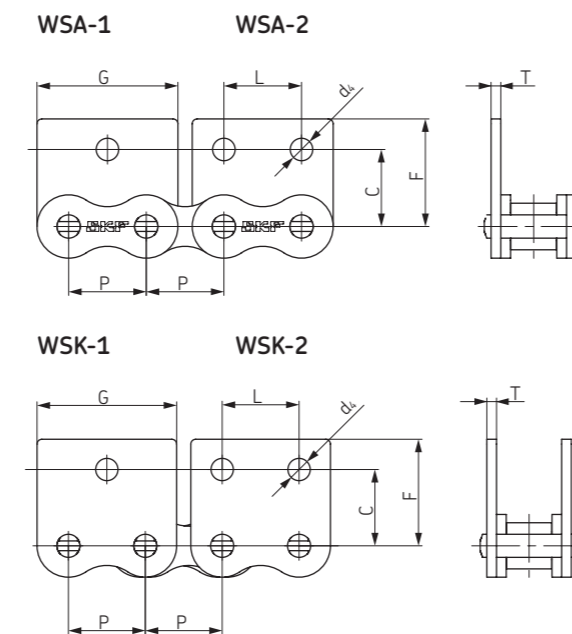

# SKF Xtra Strength Chains

The use of tensile strength as a quality basis for chain performance is not entirely correct. While tensile strength is important to use in calculating the maximum chain pull, useful in lifting calculations, this does not always represent the fatigue life and performance of the chain.

The importance of the working load is particularly useful in heavy drive environments where significant shock loads are present. This in turn causes rapid elongation. This comes down to the hardness of the material used, the precision fit of the components as well as the overall size increase of the parts to offer a significant increase in allowable working load. This will in turn provide a much greater working life for the chain in demanding drive conditions.



SKF Xtra Strength Chains used in logging applications

## Tensile strength comparison

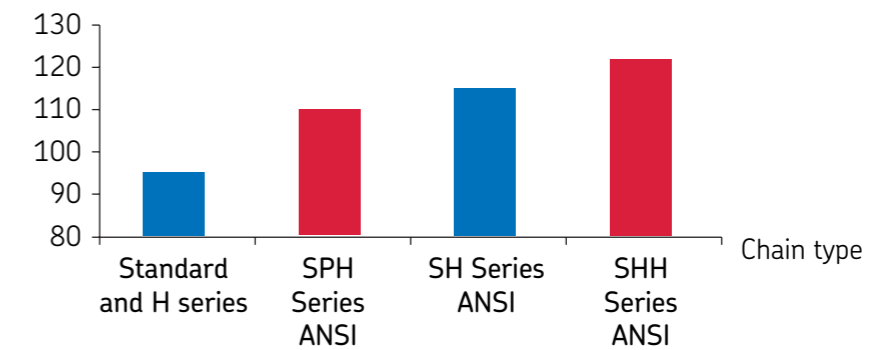

## Allowable load comparison

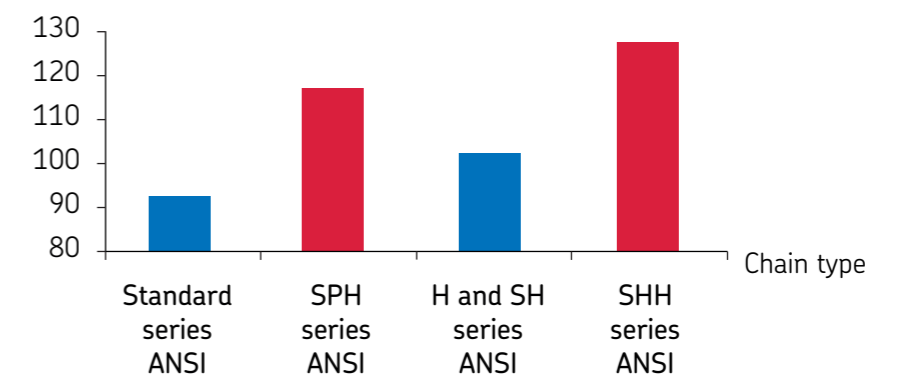



# SKF Xtra Strength H Chains

SKF Xtra Strength H Chains differ from standard ANSI chains slightly due to the fact that the thicker link plates correspond to the next larger size of ANSI roller chains. Therefore, H Series chains provide the capability to absorb approximately 10% higher shock loads. The ultimate tensile strength will be the same. SKF Xtra Strength H Chains which are especially suited to applications where shock loads are higher and operating speeds are lower as well as other severe operating conditions.

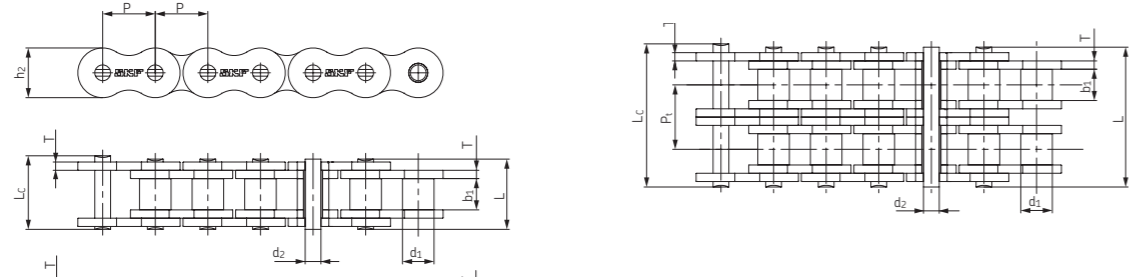

ANSI Chain No.	BS/ISO Chain No.	Pitch P	Roller diameter d <sub>1</sub> max	Width between inner plates b <sub>1</sub> max	Pin diameter d <sub>2</sub> max	Pin length L max	Pin length L <sub>C</sub> max	Pin length L <sub>C</sub> max	Inner plate height h <sub>2</sub> max	Plate thickness T max	Transverse pitch Pt	Ultimate tensile strength Q min	Average tensile strength Q <sub>0</sub>	Weight per meter q	Designation
–	–	mm	mm	mm	mm	mm	mm	mm	mm	mm	mm	kN	kN	kg/m	–
35H-1*	–	9,525	5,08	4,77	3,58	13,3	14,3	–	9,0	1,50	–	7,9	10,8	0,41	PHC 35H-1...
40H-1	08AH-1	12,700	7,95	7,85	3,96	18,8	19,9	–	12,00	2,03	–	14,1	19,1	0,82	PHC 40H-1...
50H-1	10AH-1	15,875	10,16	9,40	5,08	22,1	23,4	24,4	15,09	2,42	–	22,2	30,2	1,25	PHC 50H-1...
60H-1	12AH-1	19,050	11,91	12,57	5,94	29,2	31,0	31,6	18,00	3,25	–	31,8	42,7	1,87	PHC 60H-1...
80H-1	16AH-1	25,400	15,88	15,75	7,92	36,2	37,7	39,4	24,00	4,00	–	56,7	71,4	3,10	PHC 80H-1...
100H-1	20AH-1	31,750	19,05	18,90	9,53	43,6	46,9	46,9	30,00	4,80	–	88,5	112,4	4,52	PHC 100H-1...
120H-1	24AH-1	38,100	22,23	25,22	11,10	53,5	57,5	57,5	35,70	5,60	–	127,0	160,9	6,60	PHC 120H-1...
140H-1	28AH-1	44,450	25,40	25,22	12,70	57,6	62,2	62,2	41,00	6,40	–	172,4	217,3	8,30	PHC 140H-1...
160H-1	32AH-1	50,800	28,58	31,55	14,27	68,2	73,0	73,0	47,80	7,20	–	226,8	285,8	10,30	PHC 160H-1...
180H-1	36AH-1	57,150	35,71	35,48	17,46	75,9	81,6	–	53,60	8,0	–	281,0	341,8	14,83	PHC 180H-1...
200H-1	40AH-1	63,500	39,68	37,85	19,85	86,6	93,5	93,5	60,00	9,50	–	353,8	444,5	19,16	PHC 200H-1...
240H-1	48AH-1	76,200	47,63	47,35	23,81	109,6	115,9	–	72,30	12,70	–	510,3	622,5	30,4	PHC 240H-1...
60H-2	12AH-2	19,050	11,91	12,57	5,94	55,3	57,1	57,7	18,00	3,25	26,11	63,6	84,5	3,71	PHC 60H-2...
80H-2	16AH-2	25,400	15,88	15,75	7,92	68,8	70,3	72,0	24,00	4,00	32,59	113,4	145,3	6,15	PHC 80H-2...
100H-2	20AH-2	31,750	19,05	18,90	9,53	82,7	86,0	86,0	30,00	4,80	39,09	177,0	225,9	9,03	PHC 100H-2...
120H-2	24AH-2	38,100	22,23	25,22	11,10	102,4	106,4	106,4	35,70	5,60	48,87	254,0	322,7	13,13	PHC 120H-2...
140H-2	28AH-2	44,450	25,40	25,22	12,70	109,8	114,4	114,4	41,00	6,40	52,20	344,8	437,7	16,60	PHC 140H-2...
160H-2	32AH-2	50,800	28,58	31,55	14,27	130,1	134,9	134,9	47,80	7,20	61,90	453,6	571,6	20,20	PHC 160H-2...
200H-2	40AH-2	63,500	39,68	37,85	19,85	164,9	171,8	171,8	60,00	9,50	78,31	707,6	894,9	38,11	PHC 200H-2...
60H-3	12AH-3	19,050	11,91	12,57	5,94	81,4	83,2	83,8	18,00	3,25	26,11	95,4	113,9	5,54	PHC 60H-3...
80H-3	16AH-3	25,400	15,88	15,75	7,92	101,4	102,9	104,6	24,00	4,00	32,59	170,1	203,5	9,42	PHC 80H-3...
100H-3	20AH-3	31,750	19,05	18,90	9,53	121,8	125,1	125,1	30,00	4,80	39,09	265,5	314,8	12,96	PHC 100H-3...
120H-3	24AH-3	38,100	22,23	25,22	11,10	151,2	155,2	155,2	35,70	5,60	48,87	381,0	444,7	19,64	PHC 120H-3...
140H-3	28AH-3	44,450	25,40	25,22	12,70	162,0	166,6	166,6	41,00	6,40	52,20	517,2	598,4	24,90	PHC 140H-3...
160H-3	32AH-3	50,800	28,58	31,55	14,27	192,0	196,8	196,8	47,80	7,20	61,90	680,4	787,3	30,10	PHC 160H-3...
200H-3	40AH-3	63,500	39,68	37,85	19,85	243,2	250,1	250,1	60,00	9,50	78,31	1061,4	1228,2	57,06	PHC 200H-3...

\* Bushing chain: d<sub>1</sub> indicates external diameter of bushing  
 For cotted add a "C" after the number of strands. For example 160H-1 with a cotted pin is designated PHC 160H-1C...  
 Standard lengths are 10 ft and 5 m. To complete designation add chain length. For example, a 5 m box of 160H-1 is PHC 160H-1X5MTR  
 For links add "C/L" for "connecting" and "O/L" for "offset" to the designation in the table

# SKF Xtra Strength SH Chain

SKF Xtra Strength SH Chains have a 25–35% greater ultimate tensile strength than ANSI heavy duty roller chains due to their thicker plates and thru hardened pins. These chains provide a greater shock load resistance and an improved service life whilst retaining the same dimensions as ANSI heavy duty series roller chains.



SKF Xtra Strength SH Chains used in the earthmoving industry

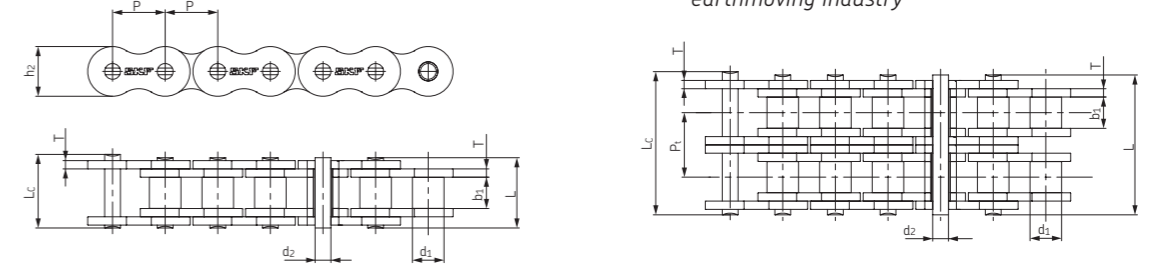

Chain No.	Pitch P	Roller diameter d <sub>1</sub> max	Width between inner plates b <sub>1</sub> max	Pin diameter d <sub>2</sub> max	Pin length L max	Pin length L <sub>C</sub> max	Inner plate height h <sub>2</sub> max	Plate thickness T max	Ultimate tensile strength Q min	Average tensile strength Q <sub>0</sub>	Weight per meter q	Designation
–	mm	mm	mm	mm	mm	mm	mm	mm	kN	kN	kg/m	–
25SH-1*	6,35	3,3	3,18	2,01	9,0	–	6,00	2,01	5,09	5,6	2,17	PHC 25SH-1X...
35SH-1*	9,525	5,08	4,77	3,58	13,3	14,3	9,00	1,50	11,00	13,6	0,41	PHC 35SH-1X...
40SH-1	12,700	7,95	7,85	3,96	18,8	19,9	12,00	2,03	22,40	24,8	0,82	PHC 40SH-1X...
50SH-1	15,875	10,16	9,40	5,08	22,1	23,4	15,09	2,42	30,40	36,2	1,25	PHC 50SH-1X...
60SH-1	19,050	11,91	12,57	5,94	29,2	31,6	18,00	3,25	44,10	50,4	1,87	PHC 60SH-1X...
80SH-1	25,400	15,88	15,75	7,92	36,2	37,7	24,00	4,00	88,20	93,0	3,10	PHC 80SH-1X...
100SH-1	31,750	19,05	18,90	9,53	43,6	46,9	30,00	4,80	116,60	129,1	4,52	PHC 100SH-1X...
120SH-1	38,100	22,23	25,22	11,10	53,5	57,5	35,70	5,60	158,20	175,3	6,60	PHC 120SH-1X...
140SH-1	44,450	25,40	25,22	12,70	57,6	62,2	41,00	6,40	206,00	266,5	8,30	PHC 140SH-1X...
160SH-1	50,800	28,58	31,55	14,27	68,2	73,0	47,80	7,20	274,00	293,0	10,30	PHC 160SH-1X...
200SH-1	63,500	39,68	37,85	19,85	86,6	93,5	60,00	9,50	506,10	562,3	19,16	PHC 200SH-1X...

\* Bushing chain: d<sub>1</sub> indicates external diameter of bushing  
 Standard lengths are 10 ft and 5 m. To complete designation add chain length. For example, a 5 m box of 100SH-1 is PHC 100SH-1X5MTR  
 For "connecting" links add "C/L" to the designation in the table.

# SKF Xtra Strength SPH Chains

SKF Xtra Strength SPH Chains have link plates of a special design and pitch holes that are critically formed to precise tolerances that improve their allowable loads by 25–32%. The pins of this chain are thru hardened for greater shock load resistance. The dimensions of these chains are the same as ANSI standard roller chains.



SKF Xtra Strength SPH Chains used in the steel industry

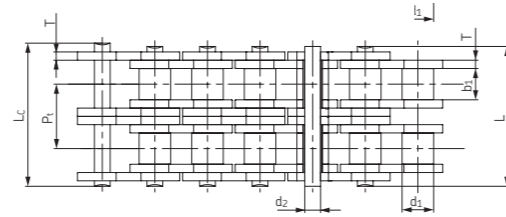
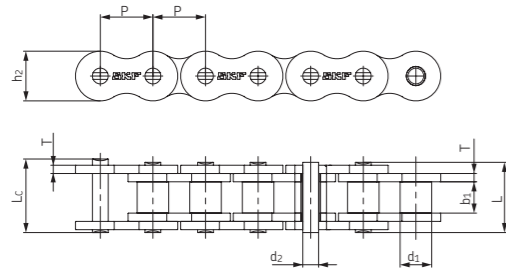

Chain No.	Pitch P	Roller diameter d <sub>1</sub> max	Width between inner plates b <sub>1</sub> max	Pin diameter d <sub>2</sub> max	Pin length L max L <sub>c</sub> max	Inner plate height h <sub>2</sub> max	Plate thickness T max	Transverse pitch Pt	Ultimate tensile strength Q min	Average tensile strength Q <sub>0</sub>	Weight per meter q	Designation
–	mm	mm	mm	mm	mm	mm	mm	mm	kN/LB	kN	kg/m	–
80SPH-1	25,400	15,88	15,75	7,94	32,7 36,5	24,10	3,20	–	77,5/17434	85,3	2,86	PHC80SPH-1X...
100SPH-1	31,750	19,05	18,95	9,54	40,4 44,7	30,10	4,00	–	115,5/25982	127,0	4,21	PHC100SPH-1X...
120SPH-1	38,100	22,23	22,22	11,11	50,3 54,3	36,20	4,80	–	165,0/37118	186,0	6,36	PHC120SPH-1X...
140SPH-1	44,450	25,40	25,22	12,71	54,4 59,0	42,20	5,60	–	222,7/50098	245,0	8,04	PHC140SPH-1X...
160SPH-1	50,800	28,58	31,55	14,29	64,8 69,6	48,20	6,40	–	285,5/64215	314,0	10,80	PHC160SPH-1X...
200SPH-1	63,500	39,68	37,85	19,85	80,3 87,2	60,30	8,00	–	445,5/100208	490,0	18,00	PHC200SPH-1X...
80SPH-2	25,400	15,88	15,75	7,94	62,7 65,8	24,10	3,20	29,29	155,0/34868	170,6	5,68	PHC80SPH-2X...
100SPH-2	31,750	19,05	18,95	9,54	76,4 80,5	30,10	4,00	35,76	231,0/51965	255,0	8,34	PHC100SPH-2X...
120SPH-2	38,100	22,23	25,22	11,11	95,8 99,7	36,20	4,80	45,44	339,0/76260	373,0	12,63	PHC120SPH-2X...
140SPH-2	44,450	25,40	25,22	12,71	103,3 107,9	42,20	5,60	48,87	445,5/100218	490,0	15,92	PHC140SPH-2X...
160SPH-2	50,800	28,58	31,55	14,29	123,3 128,1	48,20	6,40	58,55	571,0/128430	628,0	21,43	PHC160SPH-2X...
200SPH-2	63,500	39,68	37,85	19,85	151,9 158,8	60,30	8,00	71,55	892,0/200621	981,0	35,00	PHC200SPH-2X...
80SPH-3	25,400	15,88	15,75	7,94	91,7 95,1	24,10	3,20	29,29	232,5/52302	255,9	8,18	PHC80SPH-3X...
100SPH-3	31,750	19,05	18,95	9,54	112,2 116,3	30,10	4,00	35,76	347,3/78128	382,0	12,47	PHC100SPH-3X...
120SPH-3	38,100	22,23	25,22	11,11	141,4 145,2	36,20	4,80	45,44	508,0/114278	559,0	18,90	PHC120SPH-3X...
140SPH-3	44,450	25,40	25,22	12,71	152,2 156,8	42,20	5,60	48,87	668,0/150271	735,0	23,84	PHC140SPH-3X...
160SPH-3	50,800	28,58	31,55	14,29	181,8 186,6	48,20	6,40	58,55	855,5/192441	941,0	32,10	PHC160SPH-3X...
200SPH-3	63,500	39,68	37,85	19,85	223,5 230,4	60,30	8,00	71,55	1336,4/300633	1470,0	52,50	PHC200SPH-3X...

Standard lengths are 10 ft and 5 m. To complete designation add chain length. For example, a 5 m box of 100SPH-1 is PHC 100SPH-1X5MTR. For "connecting" links add "C/L" to the designation in the table.

# SKF Xtra Strength SHH Chains

SKF Xtra Strength SHH Chain's link plate thickness is usually equal to the next larger size of SKF Xtra Strength SPH Chains. Its pins are also thru hardened. The use of higher grade materials results in chains that have greater ultimate tensile strength and allowable load than SKF Xtra Strength SH Chains.



SKF Xtra Strength SHH Chains used in construction machinery

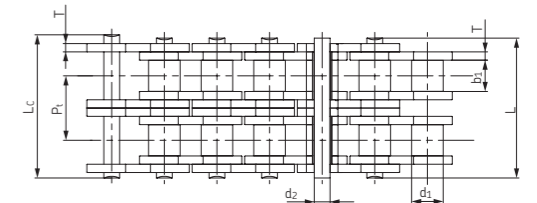
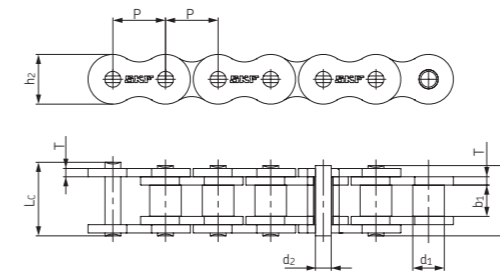

Chain No.	Pitch P	Roller diameter d <sub>1</sub> max	Width between inner plates b <sub>1</sub> max	Pin diameter d <sub>2</sub> max	Pin length L max L <sub>c</sub> max	Inner plate height h <sub>2</sub> max	Plate thickness T max	Transverse pitch Pt	Ultimate tensile strength Q min	Average tensile strength Q <sub>0</sub>	Weight per meter q	Designation
–	mm	mm	mm	mm	mm	mm	mm	mm	kN/LB	kN	kg/m	–
80SHH-1	25,400	15,88	15,75	7,94	36,2 38,9	24,10	4,00	–	89,2/20066	98,1	3,36	PHC 80SHH-1X...
100SHH-1	31,750	19,05	18,90	9,54	43,6 46,9	30,10	4,80	–	131,8/29649	145,0	4,90	PHC 100SHH-1X...
120SHH-1	38,100	22,23	25,22	11,11	53,5 57,5	36,20	5,60	–	176,0/39592	196,0	7,12	PHC 120SHH-1X...
140SHH-1	44,450	25,40	25,22	12,71	57,6 62,2	42,20	6,40	–	231,9/52149	255,0	8,88	PHC 140SHH-1X...
160SHH-1	50,800	28,58	31,55	14,29	68,2 73,0	48,20	7,20	–	294,5/66260	324,0	11,72	PHC 160SHH-1X...
200SHH-1	63,500	39,68	37,85	19,85	86,6 93,5	60,30	9,50	–	543,6/122295	598,0	19,80	PHC 200SHH-1X...
80SHH-2	25,400	15,88	15,75	7,94	68,8 72,0	24,10	4,00	32,59	178,4/40132	196,2	6,65	PHC 80SHH-2X...
100SHH-2	31,750	19,05	18,90	9,54	82,7 86,0	30,10	4,80	39,09	263,6/59299	290,0	9,71	PHC 100SHH-2X...
120SHH-2	38,100	22,23	25,22	11,11	102,4 106,4	36,20	5,60	48,87	356,4/80175	392,0	14,12	PHC 120SHH-2X...
140SHH-2	44,450	25,40	25,22	12,71	109,8 114,4	42,20	6,40	52,20	463,6/104300	510,0	17,38	PHC 140SHH-2X...
160SHH-2	50,800	28,58	31,55	14,29	130,1 134,9	48,20	7,20	61,90	588,0/132275	647,0	23,00	PHC 160SHH-2X...
200SHH-2	63,500	39,68	37,85	19,85	164,9 171,8	60,30	9,50	78,31	1091,0/245429	1200,0	38,50	PHC 200SHH-2X...
80SHH-3	25,400	15,88	15,75	7,94	101,4 104,6	24,10	4,00	32,59	267,6/60200	294,3	9,95	PHC 80SHH-3X...
100SHH-3	31,750	19,05	18,90	9,54	121,8 125,1	30,10	4,80	39,09	395,4/88948	435,0	14,53	PHC 100SHH-3X...
120SHH-3	38,100	22,23	25,22	11,11	151,2 155,2	36,20	5,60	48,87	534,5/120250	588,0	21,12	PHC 120SHH-3X...
140SHH-3	44,450	25,40	25,22	12,71	162,0 166,6	42,20	6,40	52,20	695,5/156448	765,0	25,88	PHC 140SHH-3X...
160SHH-3	50,800	28,58	31,55	14,29	192,0 196,8	48,20	7,20	61,90	882,7/198576	971,0	34,22	PHC 160SHH-3X...
200SHH-3	63,500	39,68	37,85	19,85	243,2 250,1	60,30	9,50	78,31	1627,3/366073	1790,0	57,29	PHC 200SHH-3X...

Standard lengths are 10 ft and 5 m. To complete designation add chain length. For example, a 5 m box of 100SHH-1 is PHC 100SHH-1X5MTR. For "connecting" links add "C/L" to the designation in the table.

# SKF Xtra Performance SLR Chains

The method of achieving internal lubrication of the chains is by high quality oil impregnation of the components during their manufacture and is known as sintering. The steel bushings are forged with lubricant within the material structure of the steel. During this operation, the lubricant forms a micro thin layer between the pin and internal roller surfaces.

Self-lubricating chains provide excellent wear life without further lubrication. In addition self-lubricating chain pins are nickel-plated to ensure a very smooth running surface that will not wear the self-lubricating bushes and will provide a long term, internal lubrication. The link plates are black phosphate coated. The self-lubricating chains are interchangeable with standard roller chains.

In some applications using self-lubricating chains, the amount of time to elongate when compared with non lubricated standard chains, have seen life increases from 5 – 10 times, further increasing machine up-time and reliability. These chains can also be used as a base chain for attachment chains, which are commonly required in the printing and packaging industries.

## Application

As self-lubricating chains do not require lubrication they are suitable for applications where lubrication is not possible or practical and these chains can offer a long-lasting maintenance free solution. Contamination of the final product from oil spillage or oil mist is a major reason for the lubrication-free demand in the paper, packaging, electronics, white and brown goods manufacturing sectors. In addition, if lubrication can be avoided altogether then planned lubrication intervals are unnecessary and maintenance costs are reduced accordingly.



SKF Xtra Performance SLR Chains used on food processing machinery

## SKF Xtra Performance SLR Chains vs standard chains

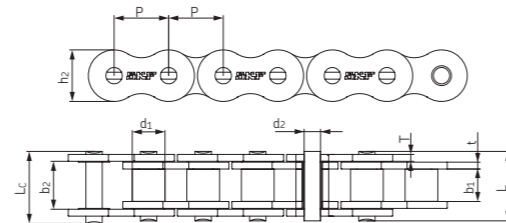
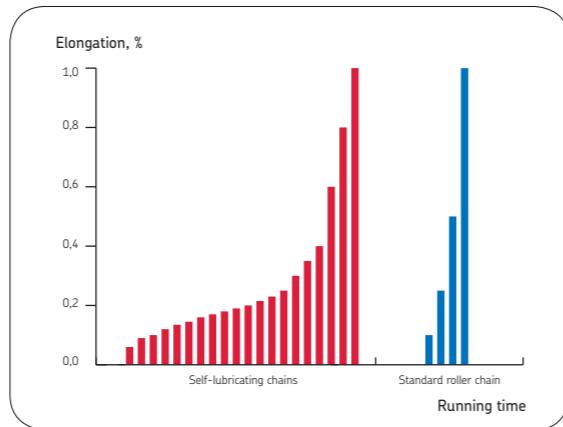

Chain No.	Pitch	Roller diameter	Width between inner plates	Width between outer plates	Pin diameter	Pin length			Inner plate height	Plate thickness		Ultimate tensile strength	Weight per meter	Designation
-	P	d <sub>1</sub> max	b <sub>1</sub> min	b <sub>2</sub> min	d <sub>2</sub> max	L max	L <sub>c</sub> max	h <sub>2</sub> max	t max	T max	Q min	q	-	
-	mm	mm	mm	mm	mm	mm	mm	mm	mm	mm	kN	kg/m	-	
08B-1SLR	12,70	8,51	7,75	13,03	4,45	18,3	19,8	11,8	1,60	1,60	18,0	0,73	PHC 08B-1SLR...	
10B-1SLR	15,88	10,16	9,65	13,75	5,08	19,9	21,6	14,7	1,70	1,70	22,4	0,97	PHC 10B-1SLR...	
12B-1SLR	19,05	12,07	11,68	15,75	5,72	22,5	24,2	16,0	1,85	1,85	29,0	1,20	PHC 12B-1SLR...	
16B-1SLR	25,40	15,88	17,02	27,50	8,28	38,1	40,6	21,0	4,15	3,10	60,0	2,72	PHC 16B-1SLR...	
12B-2SLR	19,05	12,07	11,68	35,21	5,72	42,0	43,6	16,0	1,85	1,85	58,0	2,42	PHC 12B-2SLR...	
16B-2SLR	25,40	15,88	17,02	57,46	8,28	68,0	71,0	21,0	4,15	3,10	106,0	5,68	PHC 16B-2SLR...	
50-1SLR	15,88	10,16	9,40	13,84	5,03	20,7	22,2	15,1	2,03	2,03	21,8	1,12	PHC 50-1SLR...	
60-1SLR	19,05	11,91	12,57	19,35	5,94	27,5	29,3	18,0	2,42	2,42	34,2	1,65	PHC 60-1SLR...	
80-1SLR	25,40	15,88	15,75	22,66	7,92	32,7	35,0	24,0	3,25	3,25	56,7	2,63	PHC 80-1SLR...	
100-1SLR	31,75	19,05	18,90	27,51	9,53	40,4	44,7	30,0	4,00	4,00	86,7	3,94	PHC 100-1SLR...	
60-2SLR	19,05	11,91	12,57	42,13	5,94	50,3	52,1	18,0	3,25	2,42	68,4	3,21	PHC 60-2SLR...	

Standard lengths are 10 ft and 5 m. To complete designation add chain length. For example, a 10 ft box of 10B-1SLR is PHC 10B-1SLRX10FT. For links add "C/L" for "connecting" and "O/L" for "offset" to the designation in the table.

# Side bow chains

Side bow (curved) chains are able to flex and twist due to extra clearance between the inner and outer side plates. They are ideal for use on curved conveyors or to transmit power under misaligned sprocket conditions. They are produced with barrel shaped pins and additional pin, bushing and link plate clearances. These features allow travel in a curved path and/or chain twist.

## Application

Side bow chains are commonly used in curved track conveyors in the bottling, packaging, canning and textile industries.

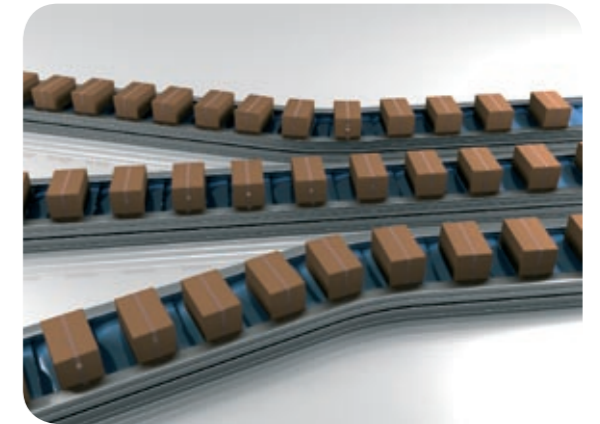

Side bow chains used in packaging machines

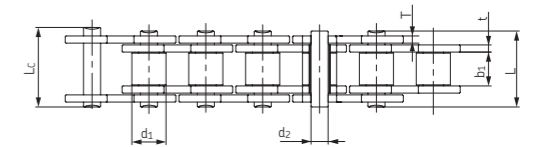
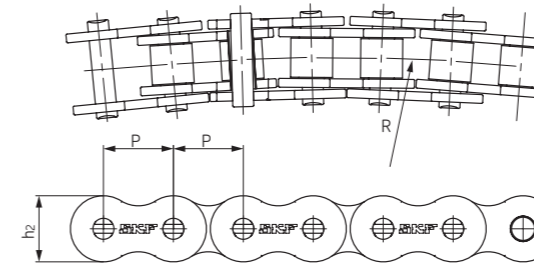

Chain No.	Pitch	Roller diameter	Width between inner plates	Pin diameter	Pin length		Inner plate height	Plate thickness		Side bow radius	Ultimate tensile strength	Average tensile strength	Weight per meter	Designation
-	P	d <sub>1</sub> max	b <sub>1</sub> min	d <sub>2</sub> max	L max	L <sub>c</sub> max	h <sub>2</sub> max	t max	T max	R min	Q min	Q <sub>0</sub>	q	-
-	mm	mm	mm	mm	mm	mm	mm	mm	mm	mm	kN	kN	kg/m	-
40-1SB	12,70	7,95	7,85	3,96	16,9	18,1	11,7	1,50	1,50	350	13,8	15,2	0,80	PHC 40-1SB...
43-1SB	12,70	7,95	7,85	3,45	18,3	19,5	11,7	1,50	1,50	305	12,0	13,2	0,64	PHC 43-1SB...
50-1SB	15,88	10,16	9,40	4,37	20,7	22,7	14,9	2,03	2,03	400	20,6	22,7	1,09	PHC 50-1SB...
60-1SB	19,05	11,91	12,57	5,34	26,6	28,4	18,0	2,42	2,42	500	15,7	17,3	1,54	PHC 60-1SB...
63-1SB	19,05	11,91	12,68	5,08	28,8	30,6	17,2	2,42	2,03	350	12,5	20,0	1,40	PHC 63-1SB...
80-1SB	25,40	15,88	15,75	7,19	34,0	37,3	24,0	3,25	3,25	711	40,9	42,0	2,60	PHC 80-1SB...
08B-1SB	12,70	8,51	7,75	3,97	17,4	18,7	11,8	1,60	1,60	400	14,0	15,4	0,70	PHC 08B-1SB...
10B-1SB	15,88	10,16	9,65	4,50	20,1	21,5	14,7	1,70	1,70	400	15,6	17,2	0,93	PHC 10B-1SB...
12B-1SB	19,05	12,07	11,68	5,12	23,1	24,8	16,0	1,85	1,85	500	20,5	22,6	1,16	PHC 12B-1SB...
C2050-1SB	31,75	10,16	9,40	5,08	21,3	22,6	15,0	2,03	2,03	800	21,8	24,1	0,84	PHC C2050-1SB...

Standard lengths are 10 ft and 5 m. To complete designation add chain length. For example, a 5 m box of 60-1SB is PHC 60-1SBX5MTR. For links add "C/L" for "connecting" and "O/L" for "offset" to the designation in the table.

# Hollow pin chains

Hollow pin chains offer flexibility to end-users as cross rods or extended pins may be easily inserted. Ideal for setups where spacing of cross rods or pins must be changed frequently. These chains are also available in carbon steel and stainless steel.

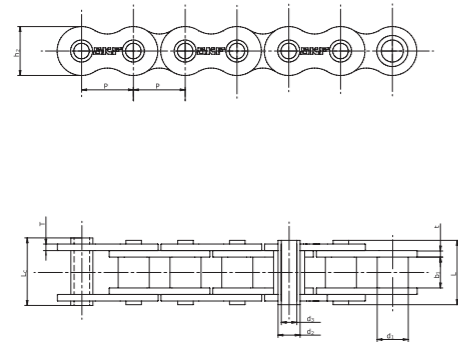

Hollow pin chain used on a newspaper conveyor

# Straight side plate chains

Straight side plate chains possess flat, rather than contoured link plates, for better sliding properties in conveyor applications. The fatigue strength and chain weight are slightly higher than for standard chains.

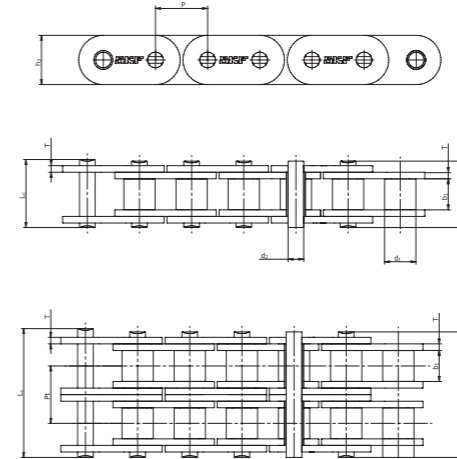

Straight side plate chain used in the automotive industry

Chain No.	Pitch	Bush Diameter	Width between inner plates			Pin length		Inner plate depth	Plate thickness	Ultimate tensile strength	Average tensile strength	Weight per meter	Designation
			b <sub>1</sub> min	d <sub>2</sub> max	d <sub>3</sub> max	L max	L <sub>c</sub> max						
–	P	d <sub>1</sub> max	b <sub>1</sub> min	d <sub>2</sub> max	d <sub>3</sub> max	L max	L <sub>c</sub> max	h <sub>2</sub> max	t/T max	Q min	Q <sub>0</sub>	q	–
	mm	mm	mm	mm	mm	mm	mm	mm	mm	kN/LB	kN	kg/m	
08BHP	12.7	8.51	7.75	6.55	4.5	16.4	17.6	11.8	1.6/1.3	11.1/2523	12.1	0.56	PHC 08B-1HP
10BHP	15.875	10.16	9.65	7.02	5.13	19.5	20.5	14.7	1.7	10.0/2272	11.5	0.86	PHC 10B-1HP
12BHP	19.05	12.07	11.68	8.09	6	22.7	23.9	16.1	1.85	14.0/3180	16	0.82	PHC 12B-1HP
16BHP	25.4	15.88	17.02	11.5	8.2	35.3	37	23.2	4.0/3.1	49.0/11136	52.2	2.26	PHC 16B-1HP
40HP	12.7	7.95	7.85	5.63	4	16.5	17.6	12	1.5	11.0/2500	12.2	0.54	PHC 40-1HP
50HP	15.875	10.16	9.4	7.03	5.13	20.7	21.9	15.09	2.03	20.0/4545	22.6	0.91	PHC 50-1HP
60HP	19.05	11.91	12.7	8.31	6	25.8	26.8	18	2.42	24.0/5455	26.9	1.29	PHC 60-1HP
80HP	25.4	15.88	15.75	11.4	8.05	32.5	33.8	24	3.25	50.0/11364	52	2.26	PHC 80-1HP
A2080HP	50.8	15.88	15.75	11.4	8.05	32.4	33.8	24	3.25	42.3/9615	46.1	1.6	PHC A2080HP

Standard lengths are 10 ft. To complete designation add chain length. For example, a 10ft box of 08-B-1HP is PHC 08B-1HPX10FT.

## Straight side plate chain – A series

ISO Chain No.	ANSI Chain No.	Pitch	Roller Diameter	Width between inner plates		Pin diameter	Pin length		Inner plate depth	Plate thickness	Transverse pitch	Ultimate tensile strength	Average tensile strength	Weight per meter	Designation
				b <sub>1</sub> min	b <sub>2</sub> max		L max	L <sub>c</sub> max							
–	–	P	max	b <sub>1</sub> min	b <sub>2</sub> max	max	L max	L <sub>c</sub> max	h <sub>2</sub> max	T max	Pt	Q min	Q <sub>0</sub>	q	–
		mm	mm	mm	mm	mm	mm	mm	mm	mm	mm	kN/LB	kN	kg/m	
C06A-1	*C35	9.525	5.08	4.77	3.58	13.3	14.3	9	1.3			7.9/1796	10.8	0.41	PHC C06A-1...
C08A-1	C40	12.7	7.95	7.85	3.96	16.6	18.8	12	1.5			14.1/3273	17.5	0.73	PHC C08A-1...
C10A-1	C50	15.875	10.16	9.4	5.08	20.7	23.3	15.09	2.03			22.2/5045	29.4	1.23	PHC C10A-1...
C12A-1	C60	19.05	11.91	12.57	5.94	28.3	18.0/18.2	2.42	2.42			31.8/7227	41.5	1.81/1.83	PHC C12A-1...
C16A-1	C80	25.4	15.88	15.75	7.92	32.7	36.5	24	3.25			66.7/12886	60.4	3.09	PHC C16A-1...
C20A-1	C100	31.75	19.05	18.9	9.53	40.4	44.7	30	4			88.5/20114	109.2	4.56	PHC C20A-1...
C24A-1	C120	38.1	22.23	25.22	11.1	50.3	54.3	35.7	4.8			127.0/28864	166.3	6.86	PHC C24A-1...
C28A-1	C140	44.45	25.4	25.22	12.7	54.4	59	41	5.6			172.4/39182	212	8.49	PHC C28A-1...
C32A-1	C160	50.8	28.58	31.55	14.27	64.8	69.6	47.8	6.4			226.8/51545	278.9	11.5	PHC C32A-1...
C06A-2	C40-2	12.7	7.95	7.85	3.96	31	33.2	12	1.5	14.38		282/6409	35.9	1.43	PHC C06A-2...
C10A-2	C50-2	15.875	10.16	9.4	5.08	38.9	41.4	15.09	2.03	18.11		444/10091	58.1	2.42	PHC C10A-2...
C12A-2	C60-2	19.05	11.91	12.57	5.94	48.8	51.1	18.0/18.2	2.42	22.78		636/14455	82.1	3.58/3.62	PHC C12A-2...
C16A-2	C80-2	25.4	15.88	15.75	7.92	62.7	65.8	24	3.25	29.29		113.4/25773	141.8	6.12	PHC C16A-2...
C20A-2	C100-2	31.75	19.05	18.9	9.53	76.4	80.5	30	4	35.76		177.0/40227	219.4	9.08	PHC C20A-2...
C24A-2	C120-2	38.1	22.23	25.22	11.1	95.8	99.7	35.7	4.8	45.44		254.0/57727	314.9	13.6	PHC C24A-2...
C28A-2	C140-2	44.45	25.4	25.22	12.7	103.3	107.9	41	5.6	48.87		344.8/78364	427.5	16.86	PHC C28A-2...
C32A-2	C160-2	50.8	28.58	31.55	14.27	123.3	128.1	47.8	6.4	58.55		453.6/103091	562.4	22.9	PHC C32A-2...
C08A-3	C40-3	12.7	7.95	7.85	3.96	45.4	47.6	12	1.5	14.38		423/9614	50	2.14	PHC C08A-3...
C10A-3	C50-3	15.875	10.16	9.4	5.08	57	59.5	15.09	2.03	18.11		666/15136	77.8	3.62	PHC C10A-3...
C12A-3	C60-3	19.05	11.91	12.57	5.94	71.5	73.9	18.0/18.2	2.42	22.78		95.4/21682	111.1	5.36/5.41	PHC C12A-3...
C16A-3	C80-3	25.4	15.88	15.75	7.92	91.7	95.1	24	3.25	29.29		170.1/38659	198.4	9.1	PHC C16A-3...
C20A-3	C100-3	31.75	19.05	18.9	9.53	112.2	116.3	30	4	35.76		265.5/60341	309.6	13.6	PHC C20A-3...
C24A-3	C120-3	38.1	22.23	25.22	11.1	141.4	145.2	35.7	4.8	45.44		381.0/86591	437.2	20.43	PHC C24A-3...
C28A-3	C140-3	44.45	25.4	25.22	12.7	152.2	156.8	41	5.6	48.87		517.2/117545	593.3	25.23	PHC C28A-3...
C32A-3	C160-3	50.8	28.58	31.55	14.27	181.8	186.6	47.8	6.4	58.55		680.4/154636	780.6	34.19	PHC C32A-3...

\* Bushing chain: d<sub>1</sub> in the table indicate the external diameter of the bushing.

Standard lengths are 10 ft. To complete designation add chain length. For example, a 10ft box of C08A-1 is PHC C08A-1X10FT.

## Straight side plate chain – B series

DIN/ISO Chain No.	Pitch	Roller Diameter	Width between inner plates	Pin diameter	Pin length		Inner plate depth	Plate thickness	Transverse pitch	Ultimate tensile strength	Average tensile strength	Weight per meter	Designation
	P	max	bi min	max	L max	L <sub>c</sub> max	h <sub>2</sub> max	T max	Pt	Q min	Q <sub>0</sub>	q	
–	mm	mm	mm	mm	mm	mm	mm	mm	mm	kN/LB	kN	kg/m	–
C08B-1	12.7	8.51	7.75	4.45	16.7	18.2	11.8	1.6		18.0/4091	19.5	0.8	PHC C08B-1...
C10B-1	15.875	10.16	9.65	5.08	19.5	20.9	14.7	1.7		22.4/5091	27.9	1.06	PHC C10B-1...
C12B-1	19.06	12.07	11.68	5.72	22.5	25.2	16	1.85		29.0/6591	32.2	1.32	PHC C12B-1...
C16B-1	25.4	15.88	17.02	8.28	36.1	39.1	21.0/24.0	4.15/3.1		60.0/13636	72.8	3.08/3.49	PHC C16B-1...
C20B-1	31.75	19.05	19.56	10.19	41.3	45	26.4	4.5/3.5		95.0/21591	106.7	4.16	PHC C20B-1...
C24B-1	38.1	25.4	25.4	14.63	53.4	57.8	33.2	6.0/4.8		160.0/36364	178	7.47	PHC C24B-1...
C28B-1	44.45	27.94	30.99	15.9	66.1	69.5	36.7	7.5/6.0		200.0/45455	222	9.9	PHC C28B-1...
C32B-1	50.8	29.21	30.99	17.81	66	71	42	7.0/6.0		250.0/56818	277.5	10.45	PHC C32B-1...
C08B-2	12.7	8.51	7.75	4.45	31.2	32.2	11.8	1.6	13.92	32.0/7273	38.7	1.45	PHC C06B-2...
C10B-2	15.875	10.16	9.65	5.08	36.1	37.5	14.7	1.7	16.59	44.5/10114	57.8	2	PHC C10B-2...
C12B-2	19.05	12.07	11.68	5.72	42	44.7	16	1.85	19.46	57.8/13136	66.1	2.62	PHC C12B-2...
C16B-2	25.4	15.88	17.02	8.28	68	71	21.0/24.0	4.15/3.1	31.88	106.0/24091	133	6.10/6.92	PHC C16B-2...
C20B-2	31.75	19.05	19.56	10.19	77.8	81.5	26.4	4.5/3.5	36.45	170.0/38636	211.2	8.23	PHC C20B-2...
C24B-2	38.1	25.4	25.4	14.63	101.7	106.2	33.2	6.0/4.8	48.36	280.0/63636	319.2	14.77	PHC C24B-2...
C28B-2	44.45	27.94	30.99	15.9	124.6	129.1	36.7	7.5/6.0	59.56	360.0/81818	406.8	19.82	PHC C28B-2...
C32B-2	50.8	29.21	30.99	17.81	124.6	129.6	42	7.0/6.0	58.65	450.0/102273	508.5	20.94	PHC C32B-2...
C08B-3	12.7	8.51	7.75	4.45	45.1	46.1	11.8	1.6	13.92	47.5/10796	57.8	2.1	PHC C08B-3...
C10B-3	15.875	10.16	9.65	5.08	52.7	54.1	14.7	1.7	16.59	66.7/15159	84.5	2.87	PHC C10B-3...
C12B-3	19.05	12.07	11.68	5.72	61.5	64.2	16	1.85	19.46	86.7/19706	101.8	3.89	PHC C12B-3...
C16B-3	25.4	15.88	17.02	8.28	99.8	102.9	21.0/24.0	4.15/3.1	31.88	160.0/36364	203.7	9.12/10.34	PHC C16B-3...
C20B-3	31.75	19.05	19.56	10.19	114.2	117.9	26.4	4.5/3.6	36.45	250.0/56818	290	11.34	PHC C20B-3...
C24B-3	38.1	25.4	25.4	14.63	150.1	154.6	33.2	6.0/4.8	48.36	425.0/96591	493	22.1	PHC C24B-3...
C28B-3	44.45	27.94	30.99	15.9	184.2	188.7	36.7	7.5/6.0	59.56	530.0/120454	609.5	29.64	PHC C28B-3...
C32B-3	50.8	29.21	30.99	17.81	183.2	188.2	42	7.0/6.0	58.55	670.0/152273	770.5	31.27	PHC C32B-3...

Standard lengths are 10 ft. To complete designation add chain length. For example, a 10ft box of C08B-1 is PHC C08B-1X10FT.

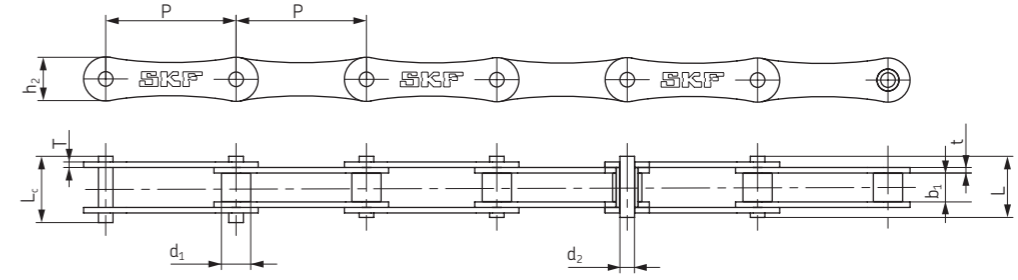

ANSI Chain No.	BS/ISO Chain No.	Pitch	Roller diameter	Width between inner plates	Pin diameter	Pin length		Inner plate height	Plate thickness		Ultimate tensile strength	Average tensile strength	Weight per meter	Designation
		P	d <sub>1</sub> max	b <sub>1</sub> min	d <sub>2</sub> max	L max	L <sub>c</sub> max	h <sub>2</sub> max	t max	T max	Q min	Q <sub>0</sub>	q	
–	–	mm	mm	mm	mm	mm	mm	mm	mm	mm	kN	kN	kg/m	–
2040	208A	25,40	7,95	7,85	3,96	16,6	17,8	12,0	1,50	1,50	14,1	16,7	0,42	PHC 2040...
2050	210A	31,75	10,16	9,40	5,08	20,7	22,2	15,0	2,03	2,03	22,2	28,1	0,73	PHC 2050...
2060	212A	38,10	11,91	12,57	5,94	25,9	27,7	18,0	2,42	2,42	31,8	36,8	1,02	PHC 2060...
2080	216A	50,80	15,88	15,75	7,92	32,7	36,5	24,0	3,25	3,25	56,7	65,7	1,70	PHC 2080...
2100	220A	63,50	19,05	18,90	9,53	40,4	44,7	30,0	4,00	4,00	88,5	102,6	2,55	PHC 2100...
2120	224A	76,20	22,23	25,22	11,10	50,3	54,3	35,7	4,80	4,80	127,0	147,3	4,06	PHC 2120...
–	208B	25,40	8,51	7,75	4,45	16,7	18,2	11,8	1,60	1,60	18,0	19,4	0,45	PHC 208B...
–	210B	31,75	10,16	9,65	5,08	19,5	20,9	14,7	1,70	1,70	22,4	27,5	0,65	PHC 210B...
–	212B	38,10	12,07	11,68	5,72	22,5	25,2	16,0	1,85	1,85	29,0	32,2	0,76	PHC 212B...
–	216B	50,80	15,88	17,02	8,28	36,1	39,1	21,0	4,15	3,10	60,0	72,8	1,75	PHC 216B...
–	220B	63,50	19,05	19,56	10,19	41,3	45,0	26,4	4,50	3,50	95,0	106,7	2,62	PHC 220B...
–	224B	76,20	25,40	25,40	14,63	53,4	57,8	33,2	6,00	4,80	160,0	178,0	4,70	PHC 224B...
–	228B	88,90	27,94	30,99	15,90	65,1	69,5	36,7	7,50	6,00	200,0	222,0	6,23	PHC 228B...
–	232B	101,60	29,21	30,99	17,81	66,0	71,0	42,0	7,00	6,00	250,0	277,5	6,72	PHC 232B...

Standard lengths are 10 ft and 5 m. To complete designation add chain length. For example, a 5 m box of 2060 is PHC 2060X5MTR. For links add "C/L" for "connecting" and "O/L" for "offset" to the designation in the table.

## Double pitch roller chains

Double pitch roller chains are produced in accordance with the ASME/ANSI B29.3 (transmission series) and B29.4 (conveyor series) american roller chain standards. In general, these chains are dimensionally similar to ASME/ANSI standard products except that the pitch is double. They are available in the transmission series and the conveyor series with standard sized rollers, and the conveyor series with large (oversized) rollers. This chain is an economical choice for low speed; moderate load and long centre distance drive applications including a variety of conveyor systems and material handling equipment.



Double pitch roller chains used in agricultural applications

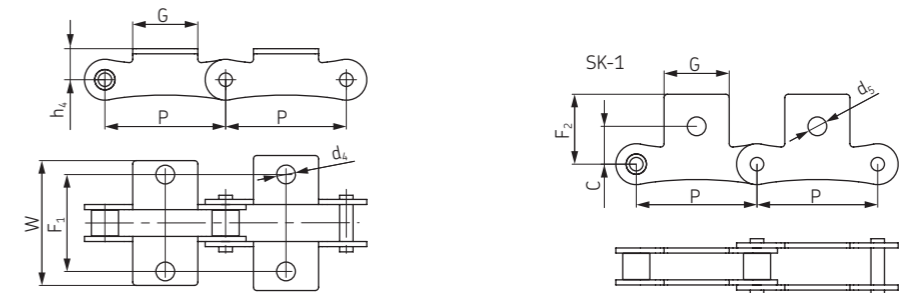

## Transmission attachments

ANSI Chain No.	BS/ISO Chain No.	P	G	F <sub>1</sub>	W	h <sub>4</sub>	d <sub>4</sub>	C	F <sub>2</sub>	d <sub>5</sub>	Designation
–	–	mm	mm	mm	mm	mm	mm	mm	mm	mm	–
2040	208A	25,40	19,1	25,4	39,6	9,1	3,4	11,1	20,5	5,5	PHC 2040...
2050	210A	31,75	23,8	31,8	49,0	11,1	5,5	14,3	25,0	6,6	PHC 2050...
2060	212A	38,10	28,6	42,9	67,8	14,7	5,5	17,5	32,9	9,2	PHC 2060...
2080	216A	50,80	38,1	55,6	87,8	19,1	6,8	22,2	43,5	11,0	PHC 2080...
2100	220A	63,50	47,6	66,6	107,5	23,4	9,2	28,6	50,4	13,0	PHC 2100...
2120	224A	76,20	57,2	79,3	121,4	27,8	10,5	33,3	55,5	15,0	PHC 2120...
–	208B	25,40	23,2	25,4	39,6	9,1	4,5	11,1	20,5	5,5	PHC 208B...
–	210B	31,75	23,8	31,8	49,0	11,1	5,5	–	–	–	PHC 210B...
–	212B	38,10	35,0	38,1	57,0	14,7	6,6	–	–	–	PHC 212B...
–	216B	50,80	44,0	50,8	84,0	19,1	6,6	–	–	–	PHC 216B...
–	220B	63,50	52,0	63,5	104,0	23,4	8,4	–	–	–	PHC 220B...
–	224B	76,20	60,0	76,2	120,0	27,8	10,5	–	–	–	PHC 224B...

To complete designation add attachment spacing and type followed by chain length. For example: PHC 2060-L1K1X10FT (2060 chain with K-1 attachment on every link, 10 ft length) Note: Also available in stainless steel. When ordering suffix with SS, for example: PHC 2060SS-L1K1X10FT. For links add "C/L" for "connecting" and "O/L" for "offset" to the designation in the table.

# Silent chains

Silent chains (or inverted tooth chains) are manufactured to GB10855 (equivalent to SC Series silent chains ANSI B29.2M), which are most commonly used for industrial applications. All silent chains are made up of stacked rows of flat, tooth shaped driving links that mesh with sprockets having compatible tooth spaces, similar to a rack and pinion mesh. Typically, chains will also contain guide links, whose purpose is to maintain proper tracking of the chain on the sprockets. Washers or spacers may be present in some chain constructions. All of these components are held together by riveted pins located at each chain joint end. Pin and rocker joint design minimizes heat and allows for low wear rates during power transmission. These chains transmit power smoothly, efficiently and economically.

## Application

Silent chains offer unique advantages and options in both power transmission and conveying applications. In power transmission applications silent chains are capable of transmitting loads and speeds that exceed the capability of all other chains and belts. Drives are compact and efficient, operating with little noise or vibration. In conveying applications silent chain provides a durable, heat resistant, non-slip, flat, conveying surface that runs with a nearly constant linear velocity. The range of available sizes is extensive.

## Flank contact

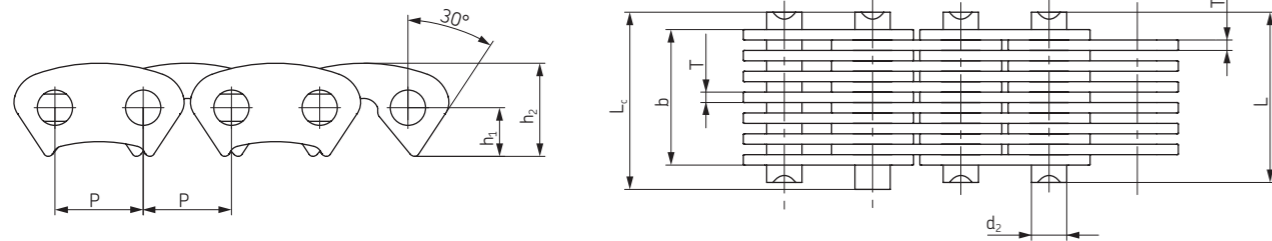

Chain No.	Pitch	Chain width	Pin diameter	Pin length		Distance from hole center to tooth	Plate height	Plate thickness	Guide form	Number of plates	Ultimate tensile strength	Average tensile strength	Weight per meter	Designation
	P	b min	d <sub>2</sub> max	L max	L <sub>c</sub> max	h <sub>1</sub>	h <sub>2</sub> max	T max	-	n	Q min	Q <sub>0</sub>	q	
-	mm	mm	mm	mm	mm	mm	mm	mm	-	-	kN	kN	kg/m	-
CL06-13,5	9,525	13,5	3,95	18,5	20,0	5,3	10,0	1,5	Outside	9	10,0	11,2	0,60	PHC CL06-13.5...
CL06-16,5		16,5		21,5	23,0				Outside	11	12,5	14,0	0,73	PHC CL06-16.5...
CL06-19,5		19,5		24,5	26,0				Outside	13	15,0	16,8	0,85	PHC CL06-19.5...
CL06-22,5		22,5		27,5	29,0				Outside	15	17,5	19,6	1,00	PHC CL06-22.5...
CL06-28,5		28,5		33,5	35,0				Inside	19	22,5	25,2	1,26	PHC CL06-28.5...
CL08-19,5	12,700	19,5	5,08	24,5	26,0	7,0	13,4	1,5	Outside	13	23,4	26,2	1,15	PHC CL08-19.5...
CL08-22,5		22,5		27,5	29,0				Outside	15	27,4	30,6	1,33	PHC CL08-22.5...
CL08-25,5		25,5		30,5	32,0				Outside	17	31,3	35,0	1,50	PHC CL08-25.5...
CL08-28,5		28,5		33,5	35,0				Inside	19	35,2	39,4	1,68	PHC CL08-28.5...
CL08-34,5		34,5		39,5	41,0				Inside	23	43,0	48,1	2,04	PHC CL08-34.5...
CL08-40,5		40,5		45,5	47,0				Inside	27	50,8	56,8	2,39	PHC CL08-40.5...
CL08-46,5		46,5		51,5	53,0				Inside	31	58,6	65,6	2,74	PHC CL08-46.5...
CL08-52,2		52,5		57,5	59,0				Inside	35	66,4	74,3	3,10	PHC CL08-52.2...
CL10-30,0	15,875	30,0	5,92	37,0	38,2	8,7	16,7	2,0	Inside	15	45,6	50,6	2,21	PHC CL10-30.0...
CL10-38,0		38,0		45,0	46,2				Inside	19	58,6	65,0	2,80	PHC CL10-38.0...
CL10-46,0		46,0		53,0	54,2				Inside	23	71,7	79,5	3,39	PHC CL10-46.0...
CL10-54,0		54,0		61,0	62,4				Inside	27	84,7	94,0	3,99	PHC CL10-54.0...
CL10-62,0		62,0		69,0	70,4				Inside	31	97,7	108,4	4,58	PHC CL10-62.0...
CL12-38,0	19,050	38,0	6,90	45,0	46,5	10,5	20,0	2,0	Inside	19	70,0	77,6	3,37	PHC CL12-38.0...
CL12-46,0		46,0		53,0	54,5				Inside	23	86,0	95,4	4,08	PHC CL12-46.0...
CL12-54,0		54,0		61,0	62,8				Inside	27	102,0	113,2	4,78	PHC CL12-54.0...
CL12-62,0		62,0		69,0	70,8				Inside	31	117,0	129,8	5,50	PHC CL12-62.0...
CL12-70,0		70,0		77,0	78,8				Inside	35	133,0	147,6	6,20	PHC CL12-70.0...
CL16-45,0	25,400	45,0	8,90	52,0	53,5	14,0	26,7	3,0	Inside	15	111,0	123,2	5,31	PHC CL16-45.0...
CL16-51,0		51,0		58,0	59,5				Inside	17	125,0	138,7	6,02	PHC CL16-51.0...
CL16-57,0		57,0		64,0	65,5				Inside	19	141,0	156,5	6,37	PHC CL16-57.0...
CL16-69,0		69,0		76,2	77,7				Inside	23	172,0	190,9	8,15	PHC CL16-69.0...
CL16-81,0		81,0		88,2	89,7				Inside	27	203,0	225,3	9,57	PHC CL16-81.0...
CL16-93,0		93,0		100,2	101,7				Inside	31	235,0	260,8	10,98	PHC CL16-93.0...
CL20-57,0	31,750	57,0	10,84	66,6	69,6	17,5	33,4	3,0	Inside	19	165,0	183,1	8,42	PHC CL20-57.0...
CL20-69,0		69,0		78,6	81,6				Inside	23	201,0	223,1	10,19	PHC CL20-69.0...
CL20-81,0		81,0		90,6	93,6				Inside	27	237,0	263,2	11,96	PHC CL20-81.0...
CL20-93,0		93,0		102,6	105,6				Inside	31	273,0	303,0	13,73	PHC CL20-93.0...
CL20-105,0		105,0		114,6	117,6				Inside	35	310,0	341,0	15,50	PHC CL20-105.0...
CL20-117,0		117,0		126,6	129,6				Inside	39	346,0	380,6	17,27	PHC CL20-117.0...

Standard lengths are 10 ft and 5 m. To complete designation add chain length. For example, a 5 m box of CL06-13.5 is PHC CL06-13.5X5MTR.

## Crotch contact

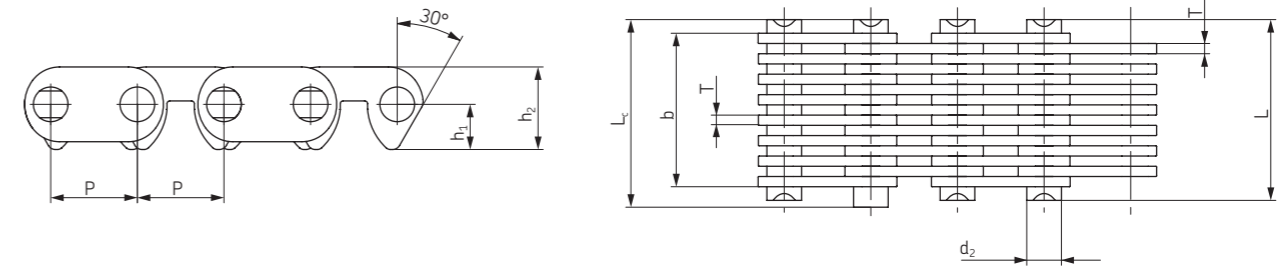

Chain No.	Pitch	Chain width	Pin diameter	Pin length		Distance from hole center to tooth	Plate height	Plate thickness	Guide form	Number of plates	Ultimate tensile strength	Average tensile strength	Weight per meter	Designation
	P	b min	d <sub>2</sub> max	L max	L <sub>c</sub> max	h <sub>1</sub>	h <sub>2</sub> max	T max	-	-	Q min	Q <sub>0</sub>	q	
-	mm	mm	mm	mm	mm	mm	mm	mm	-	-	kN	kN	kg/m	-
C4-120	12,7	19,5	5,08	24,5	26,0	6,62	12,1	1,5	Inside	13	20,0	22,2	1,20	PHC C4-120...
C4-123		22,5		27,5	29,0				Inside	15	23,0	25,5	1,37	PHC C4-123...
C4-129		28,5		33,5	35,0				Inside	19	28,5	31,6	1,72	PHC C4-129...
C4-132		31,5		35,5	38,0				Inside	21	31,5	34,9	1,89	PHC C4-132...
C4-138		37,5		42,5	44,0				Inside	25	38,0	42,1	2,22	PHC C4-138...
C4-150		49,5		54,5	56,0				Inside	33	50,0	55,5	2,90	PHC C4-150...
C4-320	12,7	19,5	5,08	24,5	26,0	6,62	12,1	1,5	Outside	13	20,0	22,2	1,21	PHC C4-320...
C4-323		22,5		27,5	29,0				Outside	15	23,0	25,5	1,38	PHC C4-323...
C4-329		28,5		33,5	35,0				Outside	19	28,5	31,6	1,73	PHC C4-329...
C4-332		31,5		36,5	38,0				Outside	21	31,5	34,9	1,90	PHC C4-332...
C4-338		37,5		42,5	44,0				Outside	25	38,0	42,1	2,23	PHC C4-338...

Standard lengths are 10 ft and 5 m. To complete designation add chain length. For example, a 5 m box of C4-120 is PHC C4-120X5MTR.

# PIV chains (Self forming tooth chains)

PIV chains (positive infinitely variable chains) are built in accordance with the ZBJ18003-89 standard for the application of chain driven gear boxes. Roller type infinitely variable speed chains are mainly used for the roller-type infinite speed variators of the textile industry. These chains are used on automotive variable speed drives and are also used in variable pitch V grooves.

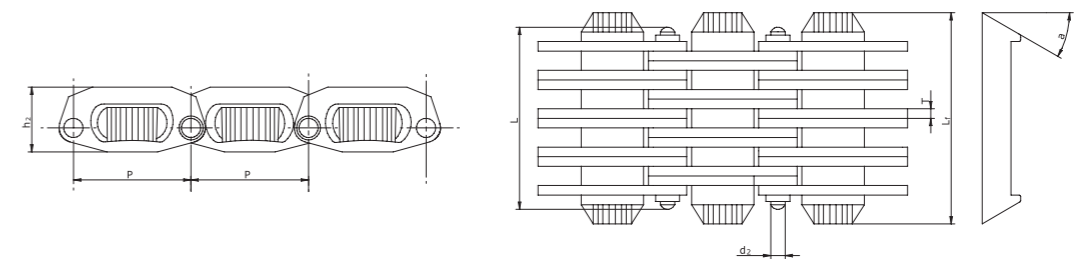

Chain No.	Pitch	Pin diameter	Pin length	Plate depth	Plate thickness	Width over friction plates	Angle of friction plates	Ultimate tensile strength	Average tensile strength	Weight per meter	Designation
	P	d <sub>2</sub> max	L max	h <sub>2</sub> max	T max	Lf	a	Q min	Q <sub>0</sub>	q	
-	mm	mm	mm	mm	mm	mm	-	kN/LB	kN	kg/m	-
A0	18,75	3	19,5	9,5	1	24	15°	9,0/2045	9,9	1	PHC A0
A1	25	3	30,1	13,5	1,5	37,8	15°	21,0/4772	23,3	2,23	PHC A1
A3	28,6	3	35,3	16	1,5	44,2	15°	38,5/8750	42,7	3,04	PHC A3
A4	36	4	48,5	20,5	1,5	58,5	15°	61,5/13977	68,2	5,54	PHC A4
A5	36	4	60,5	20,5	1,5	70	15°	71,0/16136	78,8	6,7	PHC A5

Standard lengths are 10 ft and 5 m. To complete designation add chain length. For example, a 5 m box of A1 is PHC A1X5MTR.



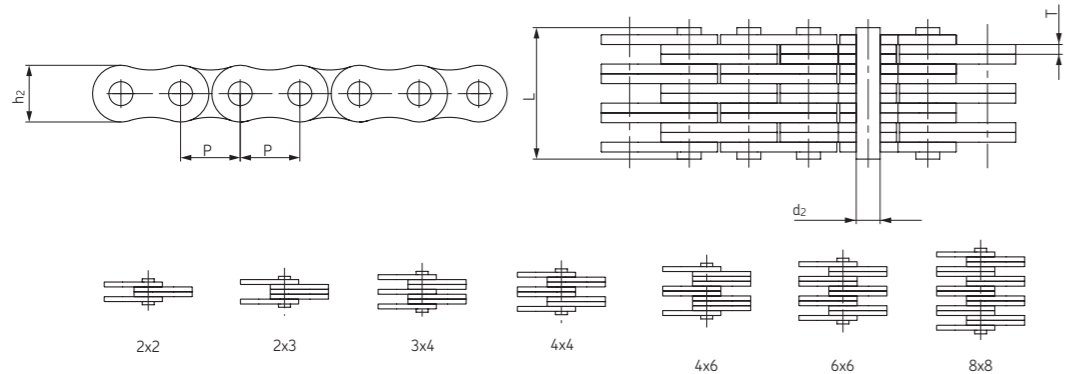

Leaf chains – ANSI BL1022-BL2088

ANSI Chain No.	BS/ISO Chain No.	Pitch P	Plate lacing	Plate height h <sub>2</sub> max	Plate thickness T max	Pin diameter d <sub>2</sub> max	Pin length L max	Ultimate tensile strength Q min	Average tensile strength Q <sub>0</sub>	Weight per meter q	Designation
BL1022	LH2022	31,75	2 x 2	30,18	4,9	11,11	25,37	115,6	150,8	3,40	PHC BL1022...
BL1023	LH2023		2 x 3				30,33	115,6	150,8	4,30	PHC BL1023...
BL1034	LH2034		3 x 4				40,23	182,4	231,6	6,00	PHC BL1034...
BL1044	LH2044		4 x 4				45,19	231,3	291,4	6,90	PHC BL1044...
BL1046	LH2046		4 x 6				55,09	231,3	291,4	8,60	PHC BL1046...
BL1066	LH2066		6 x 6				65,00	347,0	430,3	10,30	PHC BL1066...
BL1088	LH2088		8 x 8				84,81	462,6	555,1	13,80	PHC BL1088...
BL1222	LH2422	38,1	2 x 2	36,20	5,77	12,71	29,62	151,2	192,0	4,6	PHC BL1222...
BL1223	LH2423		2 x 3				35,43	151,2	192,0	5,8	PHC BL1223...
BL1234	LH2434		3 x 4				47,07	244,6	315,9	8,1	PHC BL1234...
BL1244	LH2444		4 x 4				52,88	302,5	381,1	9,3	PHC BL1244...
BL1246	LH2446		4 x 6				64,52	302,5	381,1	11,6	PHC BL1246...
BL1266	LH2466		6 x 6				76,15	453,7	543,6	13,9	PHC BL1266...
BL1288	LH2488		8 x 8				99,42	605,0	726,0	18,6	PHC BL1288...
BL1422	LH2822	44,45	2 x 2	42,24	6,55	14,29	33,55	191,3	225,7	6,1	PHC BL1422...
BL1423	LH2823		2 x 3				40,16	191,3	225,7	7,6	PHC BL1423...
BL1434	LH2834		3 x 4				53,37	315,8	372,6	10,6	PHC BL1434...
BL1444	LH2844		4 x 4				59,97	382,6	451,2	12,2	PHC BL1444...
BL1446	LH2846		4 x 6				73,18	382,6	451,2	15,2	PHC BL1446...
BL1466	LH2866		6 x 6				86,39	578,3	682,4	18,2	PHC BL1466...
BL1488	LH2888		8 x 8				112,80	765,1	902,8	24,3	PHC BL1488...
BL1622	LH3222	50,8	2 x 2	48,26	7,52	17,46	39,01	289,1	341,1	8,0	PHC BL1622...
BL1623	LH3223		2 x 3				46,58	289,1	341,1	10,0	PHC BL1623...
BL1634	LH3234		3 x 4				61,72	440,4	519,6	14,0	PHC BL1634...
BL1644	LH3244		4 x 4				69,29	573,8	680,4	16,0	PHC BL1644...
BL1646	LH3246		4 x 6				84,43	578,3	680,4	20,0	PHC BL1646...
BL1666	LH3266		6 x 6				99,57	857,4	1000,7	24,0	PHC BL1666...
BL1688	LH3288		8 x 8				129,84	1156,5	1364,6	32,0	PHC BL1688...
BL2022	LH4022	63,5	2 x 2	60,33	9,91	23,81	51,74	433,7	511,7	15,8	PHC BL2022...
BL2023	LH4023		2 x 3				61,70	433,7	511,7	19,8	PHC BL2023...
BL2034	LH4034		3 x 4				81,61	649,4	766,2	27,7	PHC BL2034...
BL2044	LH4044		4 x 4				91,57	867,4	1023,5	31,6	PHC BL2044...
BL2046	LH4046		4 x 6				111,48	867,4	1023,5	39,5	PHC BL2046...
BL2066	LH4066		6 x 6				131,39	1301,1	1535,2	47,4	PHC BL2066...
BL2088	LH4088		8 x 8				171,22	1734,8	2046,5	63,2	PHC BL2088...

Standard lengths are 10 ft and 5 m. To complete designation add chain length. For example, a 10 ft box of BL1022 is PHC BL1022X10FT.

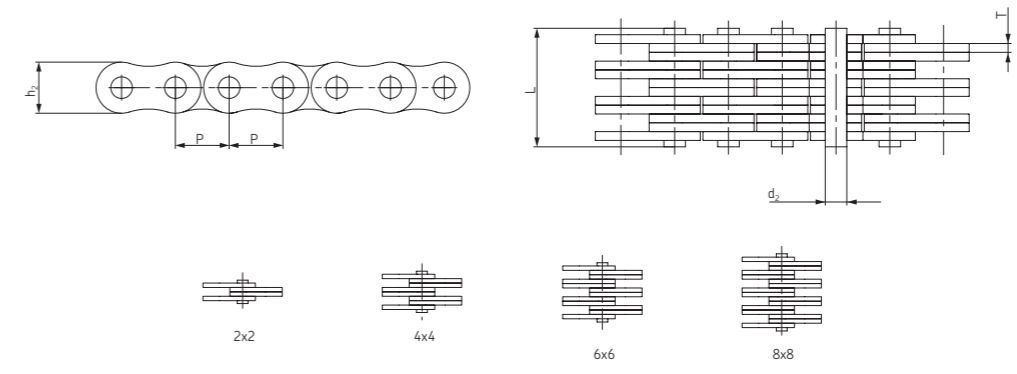

Leaf chains – BS/ISO LL0822-LL4888

BS/ISO Chain No.	Pitch P	Plate lacing	Plate height h <sub>2</sub> max	Plate thickness T max	Pin diameter d <sub>2</sub> max	Pin length L max	Ultimate tensile strength Q min	Average tensile strength Q <sub>0</sub>	Weight per meter q	Designation
LL0822	12,7	2 x 2	10,6	1,6	4,45	8,9	18,2	20,4	0,42	PHC LL0822...
LL0844		4 x 4				15,6	36,4	40,7	0,84	PHC LL0844...
LL0866		6 x 6				22,0	54,6	60	1,24	PHC LL0866...
LL0888		8 x 8				28,5	72,8	80	1,64	PHC LL0888...
LL1022	15,875	2 x 2	13,7	1,6	5,08	9,2	22,7	25,5	0,54	PHC LL1022...
LL1044		4 x 4				15,8	45,4	51	1,06	PHC LL1044...
LL1066		6 x 6				22,1	68,1	76,3	1,57	PHC LL1066...
LL1088		8 x 8				28,8	90,8	101,9	2,1	PHC LL1088...
LL1222	19,05	2 x 2	16	1,85	5,72	10,4	29,5	33,2	0,73	PHC LL1222...
LL1244		4 x 4				17,9	59,0	66,4	1,44	PHC LL1244...
LL1266		6 x 6				25,4	88,5	99,7	2,15	PHC LL1266...
LL1288		8 x 8				32,9	118,0	132,9	2,84	PHC LL1288...
LL1622	25,4	2 x 2	21	3,1	8,28	17,2	58,0	66,7	1,52	PHC LL1622...
LL1644		4 x 4				29,6	116,0	140	2,9	PHC LL1644...
LL1666		6 x 6				42,4	174,0	208,8	4,3	PHC LL1666...
LL1688		8 x 8				54,9	232,0	278	5,71	PHC LL1688...
LL2022	31,75	2 x 2	26,4	3,5	10,19	20,1	95,0	109,2	2,33	PHC LL2022...
LL2044		4 x 4				33,8	190,0	218,5	4,4	PHC LL2044...
LL2066		6 x 6				50,1	285,0	324,6	6,79	PHC LL2066...
LL2088		8 x 8				64,0	380,0	435,1	8,9	PHC LL2088...
LL2422	38,1	2 x 2	33,4	5	14,63	28,4	170,0	195,5	4,47	PHC LL2422...
LL2444		4 x 4				46,3	340,0	380,8	8,22	PHC LL2444...
LL2466		6 x 6				66,4	510,0	571,2	12,22	PHC LL2466...
LL2488		8 x 8				86,6	680,0	775,2	16,3	PHC LL2488...
LL2822	44,45	2 x 2	37,08	6	15,9	32,2	200,0	224	5,1	PHC LL2822...
LL2844		4 x 4				56,4	400,0	448	9,9	PHC LL2844...
LL2866		6 x 6				80,8	600,0	672	14,6	PHC LL2866...
LL2888		8 x 8				105,2	800,0	896	19,4	PHC LL2888...
LL3222	50,8	2 x 2	42	6,4	17,81	34,8	260,0	291,2	6,2	PHC LL3222...
LL3244		4 x 4				60,6	520,0	582,4	12,3	PHC LL3244...
LL3266		6 x 6				86,4	780,0	873,6	18,3	PHC LL3266...
LL3288		8 x 8				112,2	1040,0	1176	24	PHC LL3288...
LL4022	63,5	2 x 2	52,76	8	22,89	42,2	360,0	403,2	10,3	PHC LL4022...
LL4044		4 x 4				74,4	780,0	873,6	20	PHC LL4044...
LL4066		6 x 6				106,5	1080,0	1209,6	30	PHC LL4066...
LL4088		8 x 8				140,0	1440,0	1747,2	39,1	PHC LL4088...
LL4822	76,2	2 x 2	63,88	10	29,24	54,6	560,0	627,2	18,5	PHC LL4822...
LL4844		4 x 4				92,6	1120,0	1554,4	35,7	PHC LL4844...
LL4866		6 x 6				133,4	1680,0	1880	53	PHC LL4866...
LL4888		8 x 8				174,2	2240,0	2508,8	70,4	PHC LL4888...

Standard lengths are 10 ft and 5 m. To complete designation add chain length. For example, a 10 ft box of LL0822 is PHC LL0822X10FT.



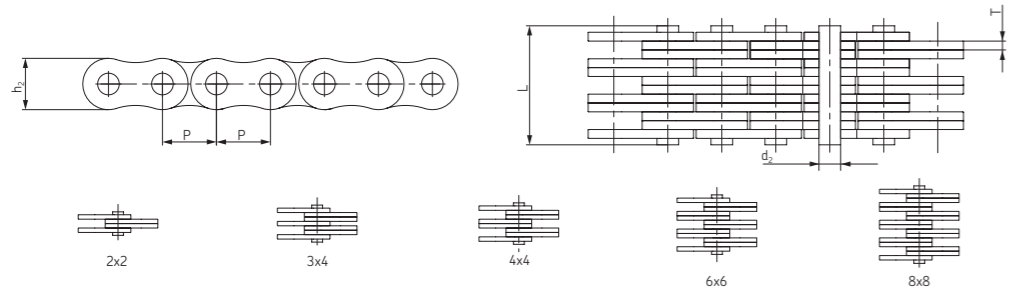

### Leaf chains – ANSI AL322-AL1688

ANSI Chain No.	Pitch	Plate lacing	Plate height	Plate thickness	Pin diameter	Pin length	Ultimate tensile strength	Average tensile strength	Weight per meter	Designation
	P		h <sub>2</sub> max	T max	d <sub>2</sub> max	L max	Q min	Q <sub>0</sub>	q	
–	mm	–	mm	mm	mm	mm	kN	kN	kg/m	–
AL322	9,525	2 x 2	7,7	1,3	3,58	6,80	9,0	10,2	0,23	PHC AL322...
AL344		4 x 4				11,60	18,0	20,0	0,46	PHC AL344...
AL422	12,7	2 x 2	10,4	1,5	3,96	8,30	14,1	16,9	0,39	PHC AL422...
AL444		4 x 4				14,40	28,2	35,2	0,74	PHC AL444...
AL466		6 x 6				20,50	42,3	52,7	1,13	PHC AL466...
AL522	15,875	2 x 2	12,8	2,03	5,08	11,05	22,0	27,5	0,64	PHC AL522...
AL534		3 x 4				17,00	33,0	46,0	1,10	PHC AL534...
AL544		4 x 4				19,40	44,0	55,0	1,25	PHC AL544...
AL566		6 x 6				27,50	66,0	82,5	1,79	PHC AL566...
AL622	19,05	2 x 2	15,6	2,42	5,94	13,00	37,0	44,4	0,86	PHC AL622...
AL644		4 x 4				22,70	63,7	78,8	1,76	PHC AL644...
AL666		6 x 6				32,20	100,1	118,6	2,60	PHC AL666...
AL688		8 x 8				42,20	133,4	156,6	3,49	PHC AL688...
AL822	25,4	2 x 2	20,5	3,25	7,92	16,00	56,7	68,6	1,54	PHC AL822...
AL844		4 x 4				29,40	113,4	135,6	3,00	PHC AL844...
AL866		6 x 6				44,20	170,0	202,3	4,46	PHC AL866...
AL1022	31,75	2 x 2	25,6	4	9,53	19,60	88,5	107,1	2,37	PHC AL1022...
AL1044		4 x 4				36,40	177,0	203,6	4,68	PHC AL1044...
AL1066		6 x 6				52,30	265,0	315,3	7,20	PHC AL1066...
AL1088		8 x 8				68,50	354,0	421,2	9,94	PHC AL1088...
AL1222	38,1	2 x 2	30,5	4,8	11,1	24,30	127,0	151,1	3,65	PHC AL1222...
AL1244		4 x 4				43,80	254,0	299,7	7,05	PHC AL1244...
AL1266		6 x 6				63,20	381,0	426,3	10,50	PHC AL1266...
AL1288		8 x 8				82,60	508,0	568,4	14,03	PHC AL1288...
AL1444	44,45	4 x 4	36,4	5,6	12,64	51,30	372,7	413,6	10,34	PHC AL1444...
AL1466		6 x 6				74,56	559,0	620,4	15,16	PHC AL1466...
AL1644	50,8	4 x 4	41,6	6,4	14,21	58,00	471,0	522,8	12,98	PHC AL1644...
AL1666		6 x 6				83,80	706,0	783,6	19,76	PHC AL1666...
AL1688		8 x 8				109,50	942,0	1045,5	25,47	PHC AL1688...

Standard lengths are 10 ft and 5 m. To complete designation add chain length. For example, a 10 ft box of AL322 is PHC AL322X10FT.

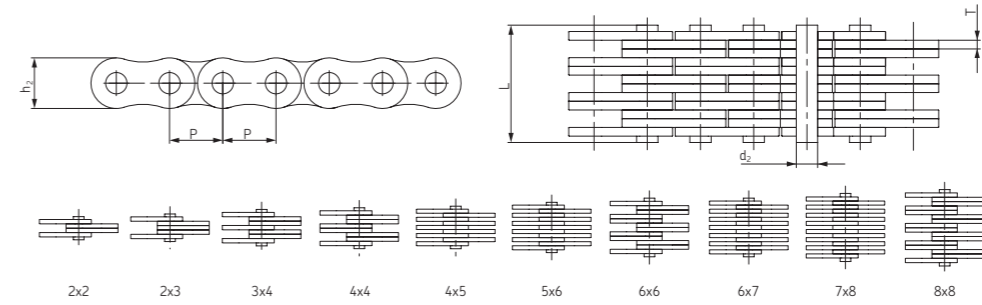

### Leaf chains – FL, F19V, FLC

Chain No.	Pitch	Plate lacing	Plate height	Plate thickness	Pin diameter	Pin length	Ultimate tensile strength	Average tensile strength	Weight per meter	Designation
	P		h <sub>2</sub> max	T max	d <sub>2</sub> max	L max	Q min	Q <sub>0</sub>	q	
–	mm	–	mm	mm	mm	mm	kN	kN	kg/m	–
FL644	5,940	4 x 4	4,7	0,60	1,85	6,6	6,50	7,8	0,13	PHC FL644...
FL666	5,940	6 x 6	4,7	0,60	1,85	9,3	9,75	11,8	0,20	PHC FL666...
FL688	5,940	8 x 8	4,7	0,60	1,85	12,0	13,00	15,6	0,25	PHC FL688...
FL844	8,000	4 x 4	6,9	0,73	2,31	7,9	10,00	12,1	0,25	PHC FL844...
FL944	9,525	4 x 4	8,7	1,04	3,28	10,4	21,00	24,7	0,43	PHC FL944...
FL966	9,525	6 x 6	8,7	1,00	3,28	14,9	31,00	36,8	0,65	PHC FL966...
F122	12,700	2 x 2	8,2	1,00	3,58	7,0	11,43	13,6	0,19	PHC F122...
F1223	12,700	2 x 3	10,2	2,03	4,45	12,8	20,00	23,8	0,61	PHC F1223...
FL1244	12,700	4 x 4	10,2	1,70	4,45	16,7	44,00	52,3	0,83	PHC FL1244...
F19V-44	19,050	4 x 4	15,2	2,42	6,50	22,4	71,00	84,3	1,73	PHC F19V-44...
F19V-66	19,050	6 x 6	15,2	2,42	6,50	32,3	106,00	125,9	2,57	PHC F19V-66...
FLC534	15,875	3 x 4	12,7	1,85	5,08	15,3	40,40	44,4	0,99	PHC FLC534...
FLC545	15,875	4 x 5	12,7	1,85	5,08	19,2	54,30	59,7	1,27	PHC FLC545...
FLC556	15,875	5 x 6	12,7	1,85	5,08	22,7	67,60	74,3	1,54	PHC FLC556...
FLC1056	31,750	5 x 6	25,4	3,25	9,53	40,6	137,90	151,0	5,44	PHC FLC1056...
FLC1067	31,750	6 x 7	25,4	3,25	9,53	47,2	165,40	181,9	6,42	PHC FLC1067...
FLC1078	31,750	7 x 8	25,4	3,25	9,53	53,8	193,00	212,0	7,40	PHC FLC1078...

Standard lengths are 10 ft and 5 m. To complete designation add chain length. For example, a 10 ft box of AL322 is PHC AL322X10FT.

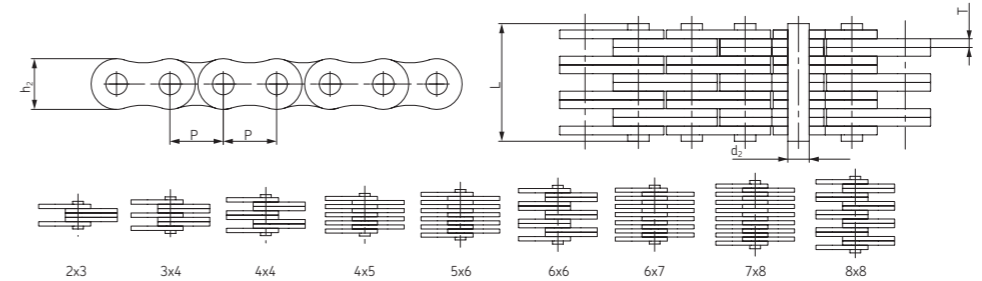

### Leaf chains – 12XX, 15XX, 19XX, 25XX

Chain No.	Pitch	Plate lacing	Plate height	Plate thickness	Pin diameter	Pin length	Chain length over 100 pitches (±0,25%)	Ultimate tensile strength	Weight per meter	Designation
	P		h <sub>2</sub> max	T max	d <sub>2</sub> max	L max		Q min	q	
–	mm	–	mm	mm	mm	mm	mm	kN	kg/m	–
1234	12,7	3 x 4	10,6	1,7	4,45	14,2	1262	31,0	0,75	PHC 1234...
1256		5 x 6				21,1		53,0	1,17	PHC 1256...
1288		8 x 8				29,9		85,0	1,70	PHC 1288...
1523	15,875	2 x 3	12,7	1,94	5,08	12,1	1580	29,0	0,75	PHC 1523...
1534		3 x 4				16,0		46,0	1,04	PHC 1534...
1544		4 x 4				18,1		58,0	1,18	PHC 1544...
1545		4 x 6				20,3		58,0	1,33	PHC 1545...
1556		5 x 6				24,0		72,0	1,63	PHC 1556...
1566		6 x 6				26,2		87,0	1,77	PHC 1566...
1567		6 x 7				28,0		90,0	1,91	PHC 1567...
1578		7 x 8				32,5		101,0	2,20	PHC 1578...
1588		8 x 8				34,0		115,0	2,34	PHC 1588...
1944	19,05	4 x 4	15,0	2,29	5,72	21,3	1891	73,0	1,58	PHC 1944...
1966		6 x 6				30,7		110,0	2,37	PHC 1966...
1988		8 x 8				40,0		140,0	3,13	PHC 1988...
2523	25,4	2 x 3	20,2	3,06	8,28	18,8	2532	72,0	1,83	PHC 2523...
2534		3 x 4				25,3		108,0	2,55	PHC 2534...
2545		4 x 5				31,6		144,0	3,26	PHC 2545...
2556		5 x 6				37,2		180,0	3,96	PHC 2556...
2567		6 x 7				43,8		216,0	4,68	PHC 2567...
2578		7 x 8				50,0		252,0	5,39	PHC 2578...
2588		8 x 8				52,8		290,0	5,77	PHC 2588...

Standard lengths are 10 ft and 5 m. To complete designation add chain length. For example, a 10 ft box OF1234 is PHC 1234X10FT.

# Maintenance decrease

SKF Power transmission and Maintenance Products together help you mount, lubricate, align and maintain your application more efficiently.

## Chain drives

By using high quality steel and paying careful attention to details in the manufacturing process SKF Chains are built for endurance. Specialized chains such as the Dacromet coated chain allow chains to be run for longer in the most corrosive surroundings.

## Pinpoint accurate shaft alignment simply achieved

The SKF shaft alignment tools TMEA Series offer you simplicity with a high degree of accuracy. These highly innovative tools feature a three-step process for correcting alignment: Measuring, aligning and documenting.

First, measure the machinery's current alignment status.

Then align the machine vertically and horizontally. Finally,

document and keep track of the alignment activities. These three simple steps allow you to easily and effectively align shafts using advanced laser technology.

These three simple steps allow you to easily and effectively align shafts using advanced laser technology.

- Compact, lightweight design
- Spirit levels allow easy and fast positioning of the measuring units
- Selectable mm or inch reading of measurement facilitates worldwide use
- Supplied in sturdy, lightweight carrying cases for portability
- Supplied with high precision SKF pre-cut shims for accurate alignment

## Extend your chain life with the oil range from SKF

SKF Chain oils come in three convenient sizes to suit the needs of most chain applications in industrial environments.

The chain oils, medium temperature, high temperature and food compatible (NSF H1), are available in 400 ml (13,52 oz.) aerosol cans, 5 liter (1,32 gallon) cans, and as an oil fill for SYSTEM 24® single point automatic lubricator.



# Design Optimization

The most efficient and economical solution for your drive can now be calculated and also be documented.

SKF is the first industrial company to offer its customers on-line calculation tools for both belt and chain drive designs. Visit [www.skfptp.com](http://www.skfptp.com) for free access and a wide choice of languages.

