





#### QUICK SELECTION / Selezione veloce

input speed ( $n_1$ ) = 1400 min<sup>-1</sup>

Output Speed $n_2$ [min <sup>-1</sup> ]	Ratio $i$	Motor power $P_{1M}$ [kW]	Output torque $M_{2M}$ [Nm]	Service factor f.s.	Nominal power $P_{1R}$ [kW]	Nominal torque $M_{2R}$ [Nm]	Available B5 motor flanges				Available B14 motor flanges				Output Shaft  standard ø14	Ratios code 
							B	C	D	E	O	P	Q	R		
							63	71	80	90	56	63	71	80		
682	2.05	0.37	5	2.0	0.73	10					C	C			1939	01
595	2.35	0.37	6	2.1	0.76	12					C	C			1740	02
500	2.80	0.37	7	2.0	0.75	14					C	C			1542	03
414	3.38	0.37	8	2.0	0.75	17					C	C			1344	04
298	4.70	0.37	12	1.7	0.64	20					C	C			1047	05
225	6.22	0.37	15	1.5	0.55	23					C	C			956	06
169	8.29	0.37	20	1.0	0.36	20					C	C			758	07
142	9.83	0.25	16	1.0	0.24	16					C	C			659	08

The dynamic efficiency is **0.98** for all ratios

 **Motor Flanges Available**  
Flange Motore Disponibili

 **B) Supplied with Reduction Bushing**  
Fornito con Bussola di Riduzione

**B) Available on Request without reduction bushing**  
Disponibile a Richiesta senza Bussola di Riduzione

 **C) Motor Flange Holes Position**  
Posizione Fori Flangia Motore

4

**EN** Unit **211A** is supplied with synthetic oil for lifetime lubrication, no maintenance is necessary. See table 1 for lubrication and recommended quantity. In table 2 please see possible radial loads and axial loads on the gearbox.

**I** Il riduttore **211A** viene fornito completo di olio sintetico per la lubrificazione permanente e non necessita di alcuna manutenzione. Vedi tab.1 per oli e quantità consigliati. In tab.2 sono presenti i carichi radiali e assiali applicabili al riduttore.

**D** Das Getriebe **211A** ist mit synthetischem Öl gefüllt und ist lebensdauergeschmiert. In Tabelle 1 ist die Schmiermenge und das empfohlene Schmiermittel angegeben. In Tabelle 2 sind die zulässigen Radial- und Axialbelastungen des Getriebes aufgeführt.

**F** Le réducteur **211A** est fourni complet avec de l'huile synthétique pour la lubrification permanente et ne nécessite aucun entretien. Voir tableau 1 concernant les huiles et les quantités conseillées. Les charges radiales et axiales applicables au réducteur sont précisées dans le tableau 2.

**E** El reductor tamaño **211A** se suministra, lubricado de por vida con aceite sintético y no requieren mantenimiento alguna. Ver tabla 1, para cantidades y aceites recomendados. En la tabla 2, se encuentran las cargas radiales y axiales admitidas por el reductor.

#### LUBRICATION 211A Oil Quantity 0.05 Lt.

**AGIP** Telium VSF 320

**SHELL** Omala S4 WE 320

For all details on lubrication and plugs check our website **tab. 1**  
Per maggiori dettagli su lubrificazione e tappi olio vedi il nostro sito web

#### RADIAL AND AXIAL LOADS

##### Output shaft

Albero di uscita

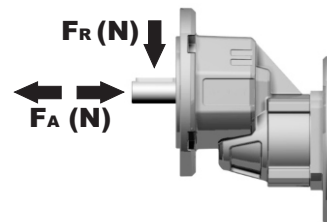

$n_2$	FA	FR
700	101	504
600	120	600
400	138	696
300	151	756
200	175	876
140	192	960

##### Input shaft

albero in entrata

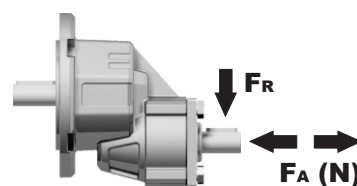

$n_2$	FA	FR
1400	168	840
900	192	960

\*Strong axial loads in the DX direction are not allowed.  
Non sono consentiti forti carichi assiali con direzione DX

tab. 2

**P211A-F...** Basic wormbox  
Riduttore base

Gearbox weight  
peso riduttore **1.40 kg**

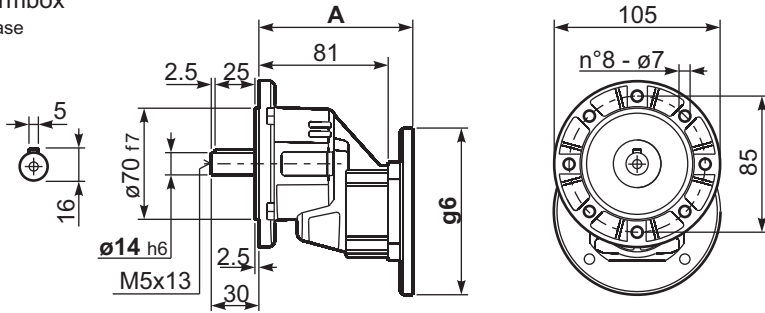

B5 Motor Flanges	A	g6	kit code
63 B5	99.5	138	K050.4.041
71 B5	97	160	K050.4.042

B14 Motor Flanges	A	g6	kit code
56 B14	97	80	KC40.4.049
63 B14	99.5	90	K050.4.047
71 B14	97	105	K050.4.045

**R211A-F...** Basic wormbox  
Riduttore base

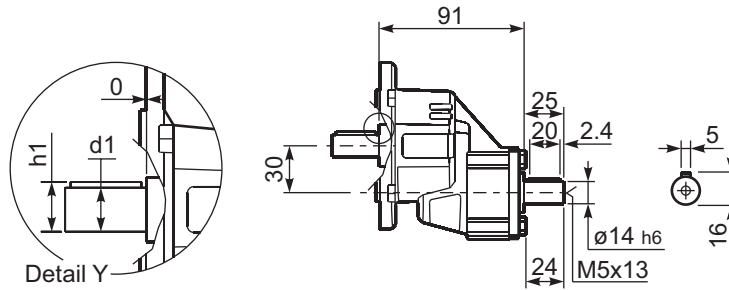

\*Available output shaft / Albero di uscita

	Shaft - d1	p1	h1	x
Standard	$\phi 14 \times 30$	5	16	M5x13