

RL 42

3FL

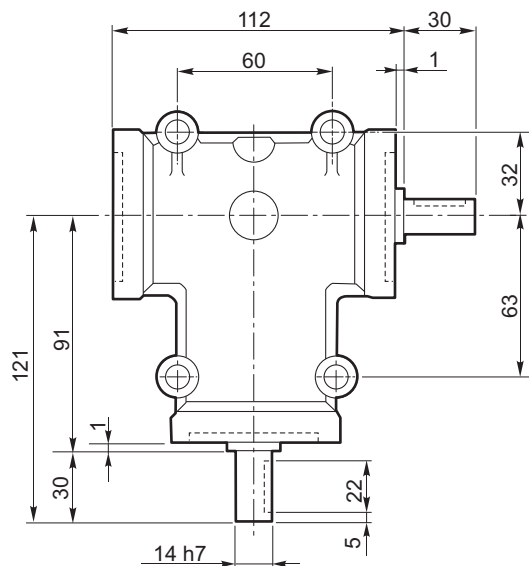

AB

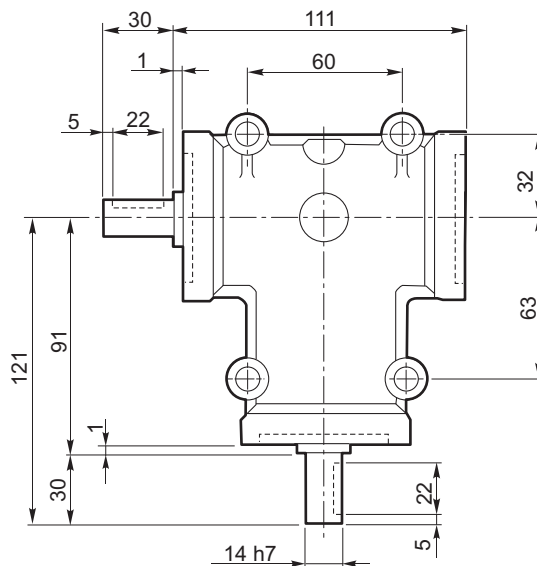

AC

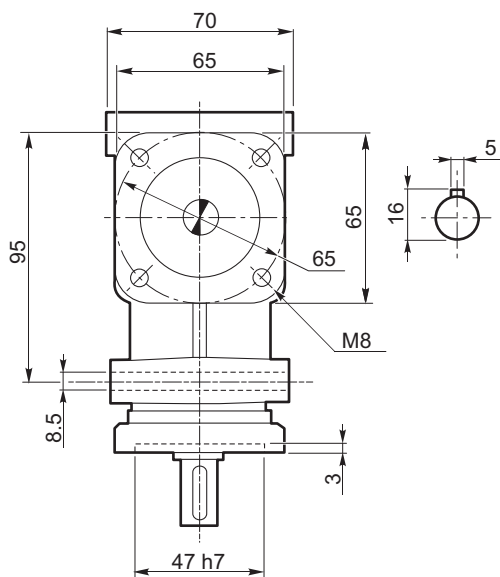

BC

